

Huth Tube Benders

**Operators and
Maintenance
Manual**

MODEL 3012

H97329

www.huthbenders.com

TO THE OWNER

INTRODUCTION:

Carefully read and understand this manual before operation begins. Every HUTH TUBE BENDER is constructed from the finest materials by highly trained, experienced craftsmen.

They have profound interest in your bender's successful performance and have prepared this manual to give you the benefit of their experience.

The manner in which you operate and the care you provide for this bender, will have a direct bearing on its continued successful performance. The manual has been prepared to make it easy for you to learn the methods for proper operation and care.

READ THE ENTIRE MANUAL. KEEP IT FOR FUTURE REFERENCE.

Huth's policy is to improve its products whenever possible. Huth reserves the right to make changes and/or improvements without incurring any obligation to do so on previously sold products.

This manual relates to benders built after January 1, 2013. For more details on specifics of older benders, please call Huth.

WARRANTY OF HUTH PRODUCTS

This warranty is made for the exclusive benefit of the original owner and is not transferrable. There is no other warranty applicable to HUTH PRODUCTS, and no representative has any authority to make any representation, promise or agreement except as stated in the warranty.

ONE YEAR WARRANTY**

For one year from the date of invoice, the seller will repair the bender if found to be defective in material and workmanship without cost to the purchaser. Following the first 90 days from the date of original invoice, replacement parts are shipped from the seller to the purchaser freight collect. Return parts are shipped prepaid to the seller.

In effecting such repairs, the seller may at its election, repair or replace any part which it finds to be defective.

Tools and dies are warranted for a period of (90) ninety days against defect in material and workmanship.

** During the first 90 days from original invoice the seller will pay freight charges for replacement of defective parts.

Model Number H3012

Serial Number _____

Date Delivered _____

Huth Equipment
260 Grant St.
PO Box 270467
Hartford, WI 53027

800-558-7808 / 262-673-9440
www.huthbenders.com

Table of Contents

Introduction	2
To the Owner	2
Warranty of Huth Products	2
1. Upon Delivery.....	4
2. Important Safety Instructions.....	4
3. Bender Terminology/Component Location.....	6
4. Bender Component Descriptions.....	8
5. Bender Controls Description List.....	9
6. Bending Tools.....	10
7. Huth Program Cards.....	12
8. Bending Operations.....	15
9. Pattern Bending.....	17
10. Swaging and Expanding.....	20
a. Swaging.....	20
b. Expanding.....	27
11. Periodic Maintenance.....	31
12. Troubleshooting.....	36
a. Electrical Troubleshooting.....	36
b. Hydraulic Troubleshooting.....	37
13. Machine Repair.....	41
a. General Repair.....	41
b. Calibration Decal Replacement.....	41
c. Hydraulic Repair.....	41
d. Electrical Repair.....	44
e. Electrical Schematics.....	48
f. Electrical Components.....	54

1. UPON DELIVERY

INTRODUCTION

Upon delivery of the Huth Bender, check the following:

- 1) Carefully uncrate and discard all packing material properly.
- 2) Inspect for signs of damage due to shipment. Report any shipping damage promptly to the carrier and Huth.
- 3) Review the enclosed Packing List. Be certain all components have been shipped.
- 4) Check the voltage and the phase of your electrical supply. All Huth Benders operate on 220 volts or more! The phase will be indicated on the motor plate and the control box plate.

NOTE: 3-phase motors must rotate counter clockwise as seen when facing the pump. To change pump rotation see page 47

Make sure that the bender is protected by the proper size breaker, dedicated to the bender. Check plug and receptacle for amperage rating.

- 5) Remove oil filler plug and replace with vented plug. See FIGURE 1-1. The oil filler elbow is found on the left side of the front leg, directly under the manual depth-of-bend plate.

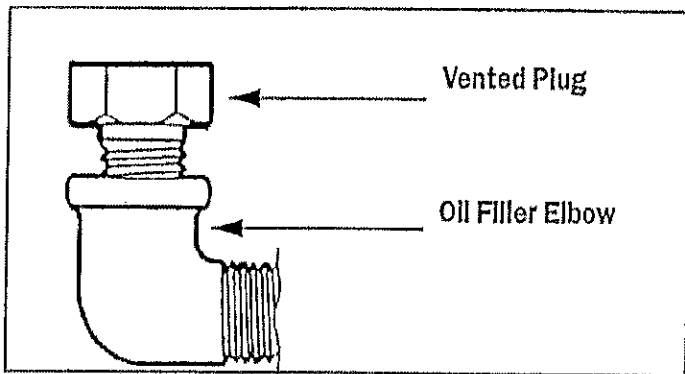

Figure 1-1

2. IMPORTANT SAFETY INSTRUCTIONS

INTRODUCTION

Common sense should always be used when equipment is operating. Ensure safe usage – **READ AND UNDERSTAND ALL SAFETY WARNINGS AND PROCEDURES BEFORE OPERATION BEGINS.**

DANGER!

1. Make sure electrical connections are good, solid connections. Never use an extension cord! If the power cord becomes damaged or frayed, have a qualified person examine and/or replace it.
2. Ensure an unrestricted power cord. Do not place cord where damage may occur.
3. Never alter electrical components used on this machine.
4. Always unplug equipment from electrical outlet when not in use. Never use the cord to pull the plug from the outlet. Grasp the plug, twist and pull to disconnect.

WARNING!

5. Unplug the machine from the power source before servicing. Electrical shock may result if this is not done.

WARNING!

6. Risk of explosion. This equipment has internal arcing or sparking parts which should not be exposed to flammable vapors. This equipment should not be located in a recessed area or below floor level.

WARNING!

7. This equipment uses earth ground protection for operator safety. This equipment must be grounded. If the ground is broken, do not use this equipment until it is repaired by a qualified service person.

DANGER!

8. Keep hands clear when dies are in motion.
9. Never place your hands or other body parts between bending dies.

DANGER!

10. Use caution while removing and installing bending dies. They are heavy.
11. Before using the swager/expander, make sure no tools have been left in the swager frame. These can cause the swager shaft to bend or break.
12. Do not use frayed or loose fitting gloves while operating this machine. Gloves alter the sense of touch and can be caught in moving parts.
13. After pipe is cut, the ends may be sharp. Use caution when handling pipe. Good practice is to file the inside edge after cutting.
14. One hand should always be kept free to operate the control. Never use another part of the body to operate the controls with the exception of a knee control plate or foot pedal.
15. When using benders equipped with foot pedals or knee controls, always ensure there is no contact with the foot pedal or knee control between bends.
16. There is a 'SAFETY CIRCLE OF SWING' around the bender. There should be at least ten feet of space on each side of the bender, so tubing will not encounter any interference during the bend.
17. If tubing being bent comes in contact with an independent piece of material and sparks are produced, IMMEDIATELY turn the bender off and remove the power cord from the receptacle. A ground wire has been disconnected and needs to be checked and/or reconnected.
18. Only one person at a time should operate the bender.
19. Safety goggles or glasses, and safety shoes should be worn when operating the bender. Everyday eye glasses only have impact resistant lenses; THEY ARE NOT SAFETY GLASSES.
20. Do not use the bender below floor or grade level.
21. Do not operate the bender without dies in their proper position.
22. Keep the expansion arbors and segments lightly greased.
23. Read and understand all decals on the bender and replace decals that are damaged or unreadable.

WARNING!

24. Before operation, check rotation of hydraulic pump/electric motor. It should rotate counter clockwise as viewed when facing the pump. (See page 47)

WARNING!

25. Never use hands to check for hydraulic leaks. Hydraulic oil under pressure can penetrate skin causing serious injury.
26. Keep hair, loose clothing, fingers and all parts of the body away from moving parts.
27. To reduce the risk of fire, do not operate equipment in the vicinity of open containers of flammable liquids.
28. Use machinery only as described in this manual. Use only manufacturer's recommended attachments.

WARNING!

29. Do not weld on bender or use bender as a fixture for welding. Damage to electrical components may result and warranty will be voided.

SAVE THESE INSTRUCTIONS

3. BENDER TERMINOLOGY / COMPONENTS LOCATION

INTRODUCTION

Before bending operations can begin it is important to familiarize yourself with the terms/names and locations of the components used on the Huth bender. Study the illustrations on the following pages and read the terms and descriptions that apply.

The descriptions are coded to the numbers and letters on the illustrations. To find the description of a component, look up the corresponding number in Section 4: Bender Components Descriptions. To find the description of the controls, look up the corresponding letter in Section 5: Bender Control Descriptions.

The terms used will be throughout the manual, and this section of the manual may be referred to in order to clarify or illustrate a location.

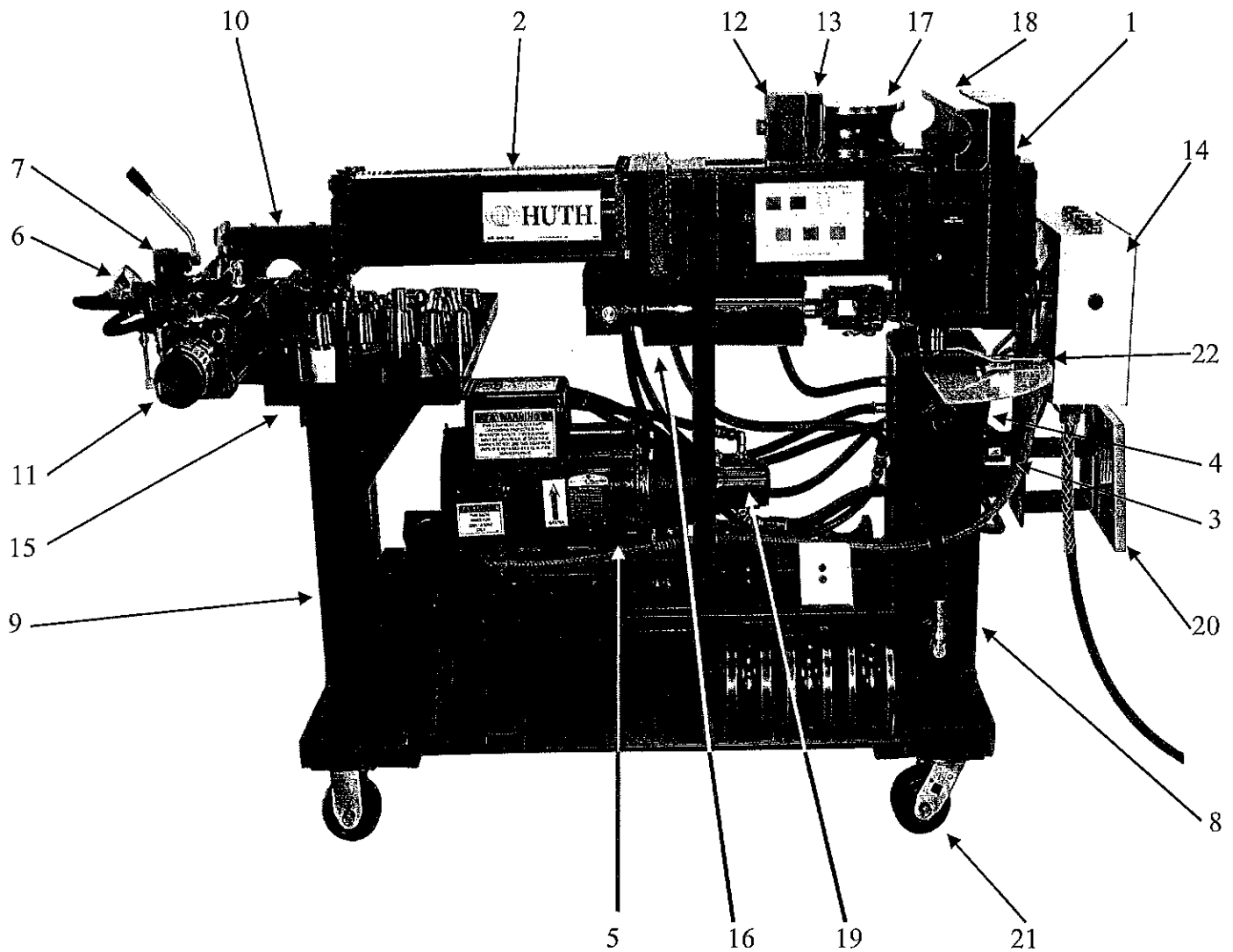

1. Swing Gate
2. Main Cylinder
3. Directional Valve (Right Side)
4. Sequence Valve (Right Side)
5. Motor
6. Hydraulic Pressure Gauge
7. Swager Control Valve
8. Hydraulic Reservoir (Front Leg)
9. Rear Leg
10. Swager
11. Expander
12. Sled
13. Sled Adaptor

14. Control Box
15. Tool Tray
16. Back Pressure Cylinder
17. Radius Die
18. Back Shoe
19. Hydraulic pump
20. Knee Control Pedal
21. Casters
22. Manual Depth of Bend Indicator

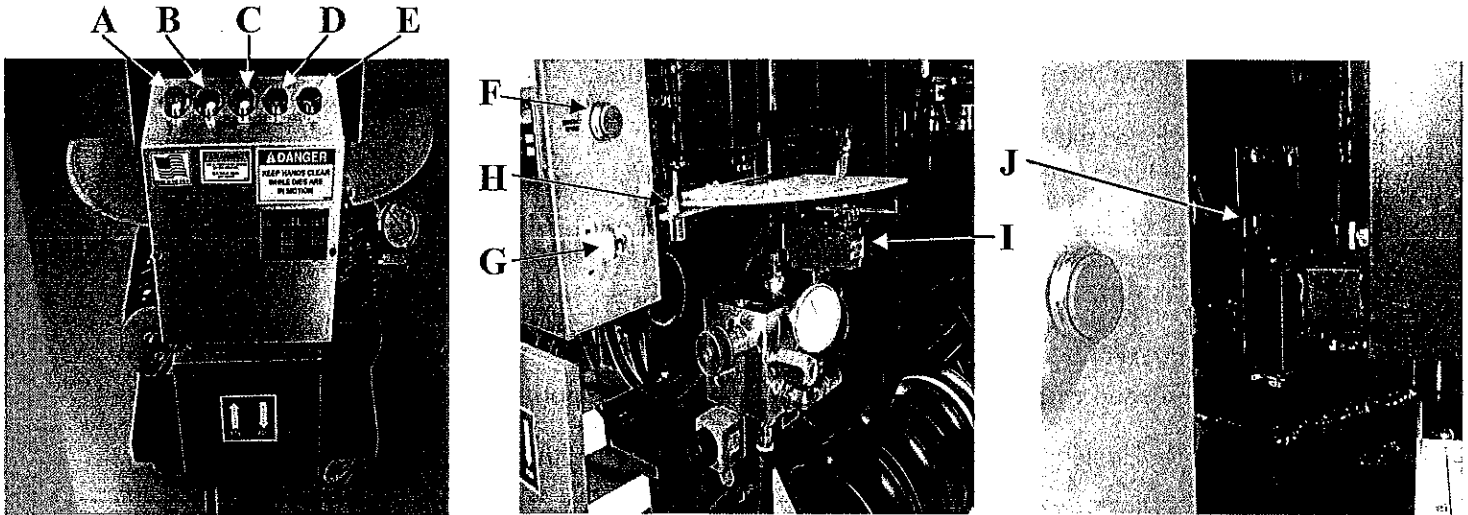

- A. Stop Button
- B. Start Button
- C. Forward Button
- D. Reverse Button
- E. Automatic Button
- F. Emergency Reverse Button
- G. Knee Pedal On/Off Switch
- H. Auto Depth of Bend Pointer
- I. Depth of Bend Limit Switch
- J. Home Position Switch

4. BENDER COMPONENT DESCRIPTION

INTRODUCTION

The following list of component descriptions is keyed to the proceeding pages. Refer to Section 3 to find the location of the component. Then read the description of the component from this list.

1. **Swing Gate** – Holds shoes in place while bending.
2. **Main Cylinder** – 5" cylinder that controls forward and reverse motion of radius bending die.
3. **Directional Valve** – Electrical solenoid valve which controls the forward and reverse motion of the main cylinder.
4. **Sequence Valve** – Control pressure to both the main and back pressure cylinder. The back pressure cylinder can be adjusted from 0 to 1,000 PSI.
5. **Motor** – Powers the hydraulic pump to produce hydraulic pressure.
6. **Hydraulic Pressure Gauge** – Measures the hydraulic pressure present while bending or swaging/expanding.
7. **Swager Control Valve** – Control pressure from the pump for the entire bender. Factory setting is 3,000 PSI. Also controls the swager/expander.
8. **Hydraulic Reservoir** – Indicates the front of the machine and is also the hydraulic reservoir.
9. **Rear Leg** – Indicates the rear of the machine. (swager/expander end)
10. **Swager** – Clamps tube in a fixed position and applies solid tooling against the end of the tube to create a shape.
11. **Expander** – Uses segmented tooling to reshape the end of a tube from within the tube.
12. **Sled** – Guides the radius bending die.

WARNING!

Do not operate or move this part without a set of dies in position.

13. **Sled Adaptor** – Holds the radius bending die to the sled.
14. **Control Box** – Houses controls and electrical components.
15. **Tool Tray** – Shelf provided for storage of tools.
16. **Back Pressure Cylinder** – Cylinder maintains pressure on the swing gates to form the bend.
17. **Radius Die** – Die allows the tubing to be formed around it through the bend. Dies come in a variety of radius and OD sizes.

WARNING!

Radius Die must be used with Back Shoe Dies in the same corresponding size.

18. **Back Shoes** – Die stretches and "pulls" the tube wrapping it around the advancing radius die.

WARNING!

Back Shoe Dies must be used with Radius Dies in the same corresponding size.

WARNING!

Never use the machine as a vise or press.

19. **Hydraulic Pump** – Driven by the motor to produce hydraulic pressure.
20. **Knee Control Pedal** – Controls forward and reverse motion on the main cylinder.
21. **Casters** – Wheel assemblies that allow the bender to be moved.
22. **Manual Depth of Bend Indicator** – Located on the left side of the bender. Indicates the gates opening in degrees.

5. BENDER CONTROLS DESCRIPTION LIST

INTRODUCTION

This list of bender control descriptions refers to the previous pages and the illustration on this page. This is meant to show the location and descriptions on the controls. Reading and understanding the description will assist you in getting the most from your Huth bender.

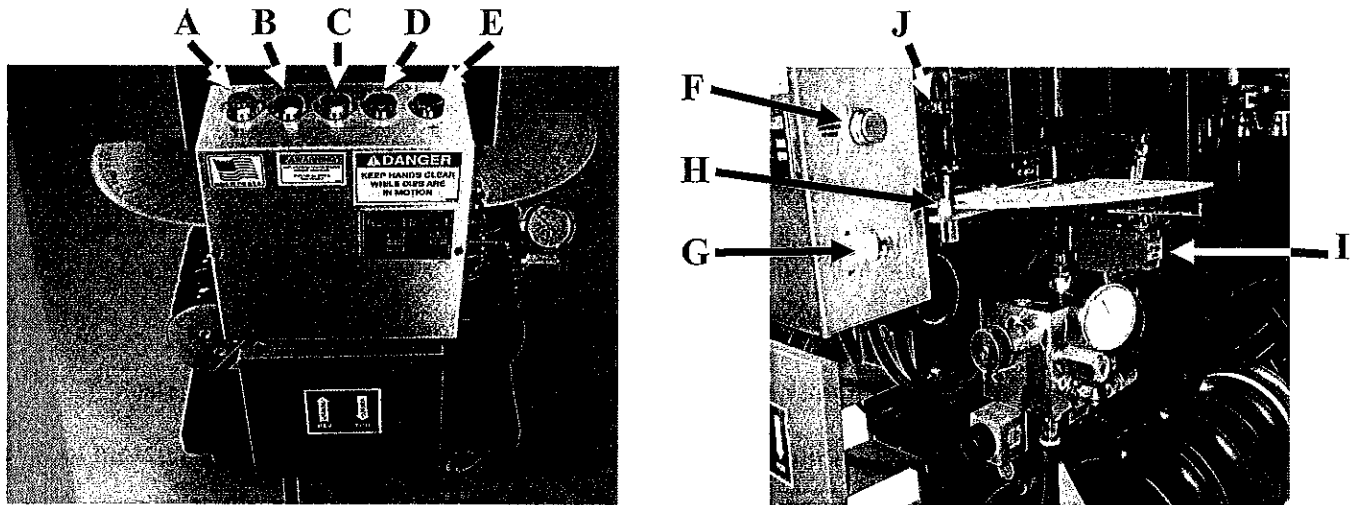

- A. **Stop Button** – Depress this button to completely stop the bender.
- B. **Start Button** – Depress this button to start the electric motor and hydraulic pump.
- C. **Forward Button** – Depress this button to manually start the forward motion of the main cylinder. When using the forward button to make a bend, the Automatic Depth of Bend Pointer should be set at 180 degrees. Using this control button will override the automatic stop, and push the pointer past the limit switch which could cause damage.
- D. **Reverse Button** – Depress this button to manually reverse the main cylinder.
- E. **Automatic Button** – Depress this button to cycle the bender automatically through the forward and reverse motion of the main cylinder. When using the Automatic Button, move the depth of bend pointer to the desired degree of bend; and depress the automatic button. The main cylinder will cycle thru the forward and reverse motion. The pointer must be moved from the 0 degree position for the automatic button to function.
- F. **Emergency Reverse Button** – Depress this button to reverse the motion of the main cylinder and return to the home position.
- G. **Knee Pedal On/Off Switch** – Supplies power to the knee pedal.
- H. **Auto Depth of Bend Pointer** – Position the pointer for the desired depth of bend.
- I. **Depth of Bend Limit Switch** – When tripped by the pointer, the forward motion of the main cylinder is stopped.
- J. **Home Position Switch** – When this switch is tripped in the automatic mode, the reverse motion of the main cylinder continues until the home position is reached.

6. BENDING TOOLS

INTRODUCTION

Three types of tools are used to bend tubing:

1. RADIUS DIE
2. BACK SHOES
3. HALF SHOES OR THREE QUARTER SHOES

All of the tools listed are called bending dies. These dies allow the tube to be stretched and pulled through the bend.

Each die is machined and sized according to tubing diameters, and the sizes are stamped on the surface of the dies. The dies come in a variety of sizes and radii. For example:

RADIUS DIES – 5" radius = 10" diameter bend
4" radius = 8" diameter bend

NOTE: The dies are made of hardened steel, but care should be given not to damage them.

NOTE: The dies perform better if they are lightly oiled and are free from flaws and foreign materials.

Huth Manufacturing has a wide variety of tooling available as well as the ability to manufacture custom tooling to fit your needs.

Radius Die

FIGURE 6-1

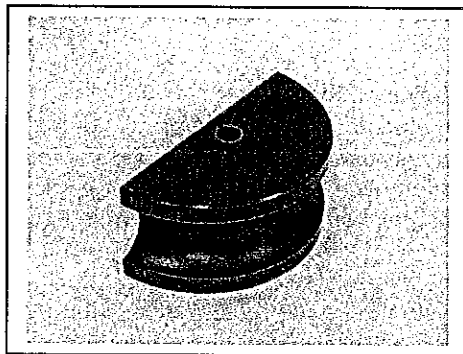

Radius Dies (see Figure 6-1) are used to produce the inside diameter of the tubing that is being bent. The dies are available in 3 ½", 4" & 5" center line radii, and in a variety of tube diameters. The radius dies and back shoes are sold separately. Always be sure to order radius and back shoe dies in matching tube sizes.

WARNING!

Radius Dies are heavy. Handle with care!

WARNING!

Radius Dies must be used with Back Shoe Dies in the same corresponding size.

WARNING!

Never use the bender as a vice or press, with or without the bending dies.

BACK SHOES

FIGURE 6-2

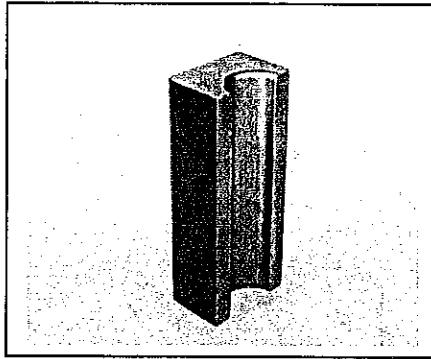

Back Shoes (see Figure 6-2) mount to the swing gates. These dies are used to clamp the tubing into position while bending and they form the outside radius of the tubing being bent. The dies are available in a variety of tubing diameters. Always be sure to order radius and back shoe dies in matching tube sizes.

WARNING!

Back Shoe Dies must be used with Radius Dies in the same corresponding size.

WARNING!

Never use the machine with or without the Back Shoe Dies in position as a vise or a press.

HALF SHOE AND THREE QUARTER SHOE DIES

FIGURE 6-3

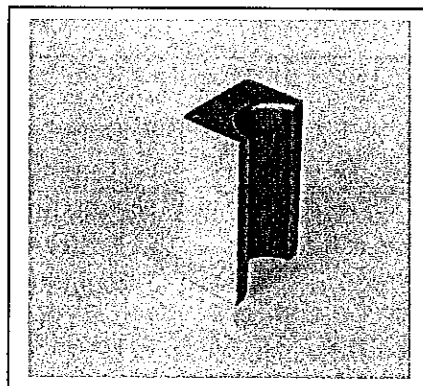

Half Shoe and Three Quarter Shoe Dies (see Figure 6-3) mount to the swing gates. The Half Shoe Dies are exactly half the length of a regular Back Shoe. The Three Quarter Shoe Dies are exactly $\frac{3}{4}$ the length of a regular Back Shoe. These dies are only used when one bend is less than 10 inches from the previous bend. Its position is always on the same side as the last bend: normally this would be on the left side. The dies are available in a variety of tubing diameters. Always be sure to order radius and back shoe dies in matching tube sizes.

WARNING!

Half Shoe Dies and Three Quarter Shoe Dies must be used with Radius Dies in the same corresponding size.

7. HUTH PROGRAM CARDS

INTRODUCTION

Huth's copyrighted cards are available on compact disc for IBM-compatible computers. Each card contains instructional data for a specific application. FIGURE 7-1 defines each section of the card.

FIGURE 7-1

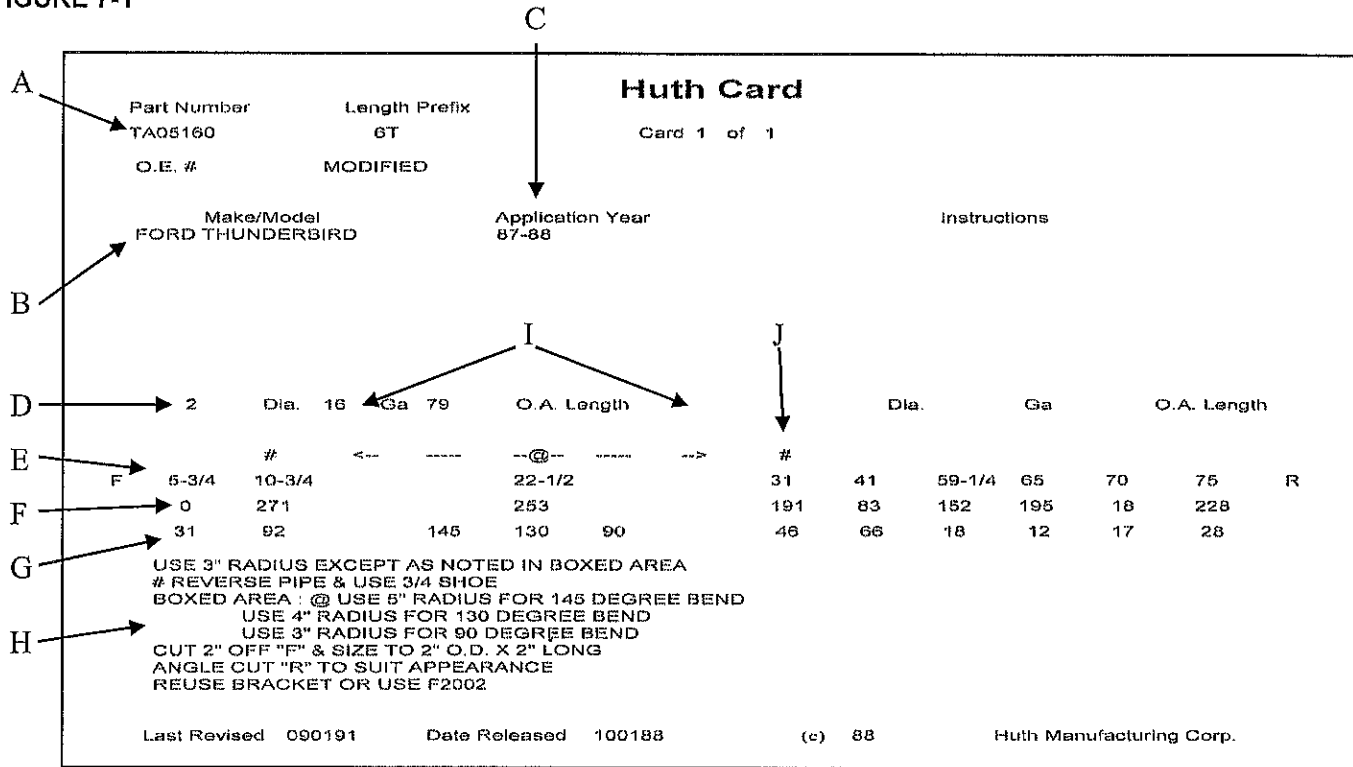

- A. Card number
- B. Make of car
- C. Year of application
- D. Tube diameter O.D., Guage, Overall length of tube or cut off point
- E. Length of bend from tube end
- F. Rotation of tube in degrees
- G. Depth of bend in degrees
- H. Bending instructions for particular applications
- I. Indicates boxed area
- J. Symbols denoting special application for this bend. Noted in area H.

It is critical you read the entire card before you attempt to set up the machine. Study the illustrations, and read the instructions that follow. All the information necessary for bending is included on the card.

First look up the vehicle you are working on in the catalog. Write down the part numbers of the parts you wish to bend. The card numbers will contain either a "T" for tail or an "E" for exhaust. Be sure to write down the complete number, ie: TA05160. Next go to the card library, enter the part number of the card, and enter search. The card will be displayed.

In some cases, the "F" (front) and the "R" (rear) are reversed; therefore, you will be making the bends or procedures from the R (rear) of the tube to the F (front). This does not affect your method of bending, but indicates which end is being worked from.

To avoid unnecessary waste of tubing, DO NOT CUT the tube until the last bend has been made. If that is not feasible, you can cut the tube at least 12" longer than the overall cut length.

TERMINOLOGY / SYMBOLS

The following information describes the symbols used on the Huth cards and the related terms that apply to the symbols.

When the symbols are indicated on the cards, the required action or step will appear in the order that it is to be done. This is located under "REMARKS". The symbols will appear above each applicable bend.

1. **@ CHANGE OF RADIUS.** One radius die is called for when using a program card. When it is necessary to make a radius change, it will be indicated on the card with the symbol @. For example, if a radius change is required from a 3" to a 4" radius die or a 5" radius die, it is indicated as such:

@ USE 5" RADIUS

When a change of radius is used in a boxed area of the card, it will be indicated if it is to be used on the remaining bends.

2. **# USE ½ or ¾ SHOE.** The ½ or ¾ shoe symbol is used when it is necessary to use the ½ shoe or ¾ shoe in place of a full shoe.

When the symbol is used in several positions and a block of wood is called for, the symbol will be stated as:

USE ½ SHOE WITH BLOCK OF WOOD ON 6th AND 7th BENDS

3. **& 852 BLANK PLATE.** The 852 blank plate symbol is used when it is necessary to use tool 852. Tool 852 is used for flattening operations or with a 1/2 shoe. When the symbol for the blank plate is used alongside the symbol for 1/2 shoe, it will be indicated on the card in the following manner:

& Use ½ Shoe with 852 Blank Plate

FIGURE 7-4. 852 Blank Plate in use.

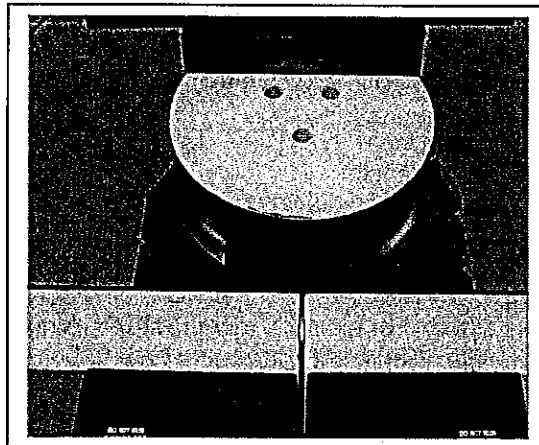

Figure 7-4 shows the 892 Blank Plate used as plate to put a flat area in the tube for clearance.

NOTE: When 852 is used with ½ shoe, it is positioned the same as when using a block of wood. This is at the end of the ½ shoe.

When a combination of a block of wood and a blank plate are employed with the ½ shoe in several positions, it will be indicated in the following manner:

*Use ½ shoe – Use block of wood on 6th and 7th bends - &852

4. **+ REVERSE PIPE.** The reverse pipe symbol is used when it is necessary to change the feed of the pipe from the right side to the left side of the bender. A reverse is used when the bend prior to the reversed bend will hit portions of the bender in the feed order.

NOTE: Unless otherwise stated, after a reverse bend is made, you must return the pipe to the original side for the next bend.

DO NOT REMOVE THE ROTATION DIAL.

At times, more than one reverse bend symbol is used in a row. In that instance, leave the tubing on the left side of the machine until no more reverse signs are shown. Then return the tubing to the original side. Under normal bending procedures, the rotation dial is on the right side of the bender. When a reverse symbol is shown, the rotation dial will be on the left side. (See figure 7-1, Item J)

5. **± REVERSE and ½ SHOE.** The reverse and ½ shoe symbol is used when it is necessary to reverse the tubing (see REVERSE PIPE symbol), and it also requires the use of the ½ shoe. (See ½ SHOE or ¾ SHOE symbol) The ½ or ¾ shoe is used on the side closest to the last bend.

When the reverse and ½ shoe with either a block of wood or the blank plate are needed, it will be indicated in the following manner:

± Reverse and ½ shoe with block of wood, or
±& Reverse and ½ shoe with 852 blank plate. (See FIGURE 7-1, Item B)

6. **BOXED AREA (← →).** Boxed areas indicate special instructions. There are several types of boxed areas that employ different terminology to best explain the manner of reproducing that particular bend. When the following situations occur, they will be indicated in the following manner:

NOTE: Boxed area statements on the Huth card may be underlined.

The first descriptive form of a boxed area is when a ½ shoe, with or without a block of wood, is used to prevent hitting the prior bend. For example:

Boxed area & note: Using two full shoes, bend to 96 degrees
then using *1/2 shoe and block of wood, bend to 115 degrees.

The second descriptive form is when a Reverse is used, for example:

Boxed area & note: +Reverse pipe then using two full shoes, bend to 96 degrees
then using *1/2 shoe and block of wood, bend to 115 degrees.

The third descriptive form is when a radius is employed, for example:

Boxed area & note: - Use 4" radius, then using two full shoes, bend to 96 degrees
then using *1/2 shoe and block of wood, bend to 115 degrees.

The fourth form is when a double strike is employed with a radius change. The prime reason is to get the maximum depth beyond the perimeters of the equipment. For example:

Boxed area & note: - Use 4" radius and two full shoes. Bend to 100 degrees, then using a 3" radius
and two full shoes, bend to 96 degrees using the same centerline and the same degree of rotation.
(See FIGURE 7-1, Item I)

There are other derivations of this double strike. For example, a triple strike using 3 different radii plus the use of the ½ shoe and the block of wood or 852 blank plate. The combinations that are to be used must be indicated in the manner stated above. The terminology used in explaining a boxed area will also employ the symbols that indicate what tooling or reverse are needed in the boxed area. The symbols above the centerline mark number will be the same as employed in the remarks. After the boxed area bends are completed, the remaining bends will be done with the original die used before the boxed area, unless otherwise stated.

SPACER PLATES

These plates are placed behind the back shoes. They are used to create more bending clearance in the gate area or to achieve a deeper bend.

Part # 91264 Spacer

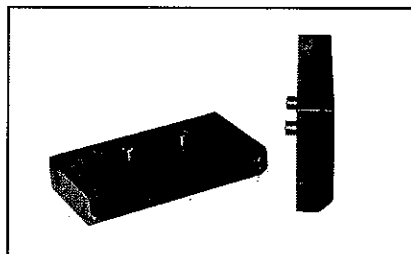

8. BENDING OPERATIONS

INTRODUCTION

WARNING!

Before operation begins, read topic, "Pump/Motor Rotation" in the section "Machine Repair".

After you have determined and selected die sizes and have installed them into the machine, there are three basic elements to consider.

1. Centerline of Bend – measured in inches.
2. Rotation – stated in degrees (change of plane).
3. Depth-of-Bend – stated in degrees.

FIRST BEND

With the above elements in mind, proceed with the following steps to produce the first bend:

1. Select straight tubing of required O.D. size and sufficient length (12" longer than the cutoff point).
2. Turn on bender.
3. Wipe tubing to remove excess oil. Place tubing in bender between back shoes and radius die with the greater portion of the tubing extending out the **left** side of the bender.
4. Rotate tubing so the seam line is facing up. This provides a start reference point for the rotation dial.
5. Engage dies until tube is held firmly with the greater portion of tubing extended from the left side of the bender.
6. Using the information on the program card, mark off in inches with a felt tip pen where each bend is to be made. Make your marks heavy, and at least halfway, around the tubing. The last mark you will make on the tube is the final cutoff or overall length.

NOTE: Do not cut the tubing until after the final bend is made.

7. Disengage the dies. Reposition the tubing in the dies, so the greater part of the tubing extends from the right side of the bender and is positioned on the first inch mark. Center inch-mark between the back shoes and engage the dies until the tube is held firmly in place.

NOTE: Pipe bending is always done by feeding the pipe from the right side of the bender to the left side.

8. Place the rotation dial on the extreme right end of the tubing, at least 12 inches from the final bend, with the numbered side facing the bender. Rotate the dial until the indicator points to zero, which should line up with the seam line, and secure the dial.

NOTE: Do not remove the rotation dial until all bends are completed.

9. For **Auto-Bending**. Set the Depth-of-Bend dial (under the right gate) by moving the pointer arm to the desired degree, and secure the pointer in position with the thumb screw.

NOTE: The pointer must be accurately adjusted and secured. It must be on the degree marking that is stated on the program card. A variance of one or two degrees can result in improper fitting tubing that needs to be scrapped.

Next depress the AUTOMATIC button. The bender will start and continue the bending operation, reverse itself and stop

(unless you stop or reverse the bender by using the REVERSE or EMERGENCY REVERSE buttons).

10. For Manual Bending. When using the FORWARD button (manual operation) to make the bend, set the right Depth of bend plate to 180 degrees, thus avoiding damage to the limit switches. Read the Depth of bend plate on the left side of the bender for the degree of depth-of-bend.

To manual bend, depress the FORWARD button, or press the right side of the knee pad, and bend until the manual depth-of-bend indicator on the left side of the bender indicates the desired bend. Then use the reverse button to return to home.

SECOND AND SUBSEQUENT BENDS

For the second and subsequent bends, proceed as follows:

1. Retract the dies until the tubing is free.
2. Slide the tubing to the left until the next inch-mark is lined up with the center of the back shoes.
3. Engage the dies until the tubing is snug, but movable.
4. Rotate the tubing until the desired setting is obtained on the rotation dial.
5. Set the Automatic Depth-of-Bend indicator for the desired depth-of-bend if you wish to Auto Bend or insure the pointer is at 180 degrees to manual bend.
6. Depress the AUTO button, or manually use the FORWARD button, or press the right side of the knee pad. Refer to the manual depth-of-bend indicator on the left side of the bender.
7. After the bend is made, slide the tubing to the next mark; and repeat the above operations until the last bend has been made.

NOTE: HALF SHOES – If a bend is required that would be close to the last bend, use the half shoe. Always place the half shoe on the side with the previous bend.

FIGURE 8-1

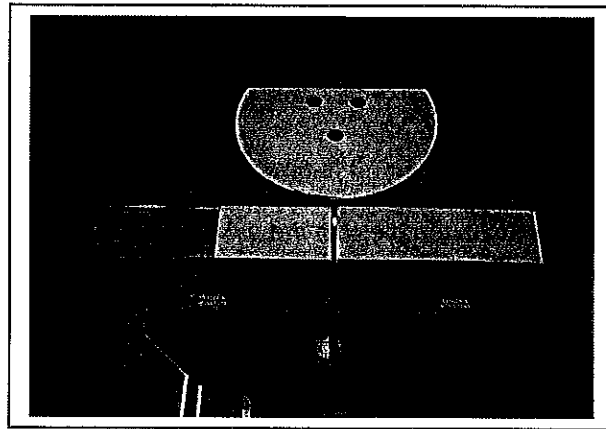

Figure 8 – 1: Block of wood being used with half shoe.

NOTE: BLOCK OF WOOD – Some exhaust system applications require a “cushion” to accurately bend a pipe. The term “Use block of wood” appears on some program cards. Use a piece of wood approximately 2” x 4” x 4”. Remove one back shoe (normally the left one) and replace it with the appropriate O.D. size half shoe. Place the block of wood next to the half shoe and proceed to make the bend. The wood will crush as the bend is being made, but the tubing will not be affected.

8. When all bends are complete, remove the rotation dial and cut the tubing at the cutoff line.
9. Complete the end finishing of the tubing as required. (See Section 11 “Swaging and Expanding”)

9. PATTERN BENDING

INTRODUCTION

When program cards are not available, you can bend tubing by using an existing pipe as a master pattern, or you can make a wire pattern to replicate the pipe. It is recommended you create a program card to document the pipe you will create.

In order to produce the program card, it will be necessary to review Section 7 "Huth Program Cards". The symbols and terms discussed in that section will aid you in the creation of your new program card.

To pattern bend (bend tubing without the aid of a program card), proceed as follows:

1. Select the proper tubing and die set to do the job.
2. Place the tubing in the bender with the greater portion of the tubing protruding out the right side of the bender.
3. Place the master pattern (tail pipe or wire pattern) on the top of the back shoes so that the first bend is centered between the shoes.

NOTE: The tubing must fill the full cavity of the back shoe. It may be cut shorter after the pipe is made.

FIGURE 9-1

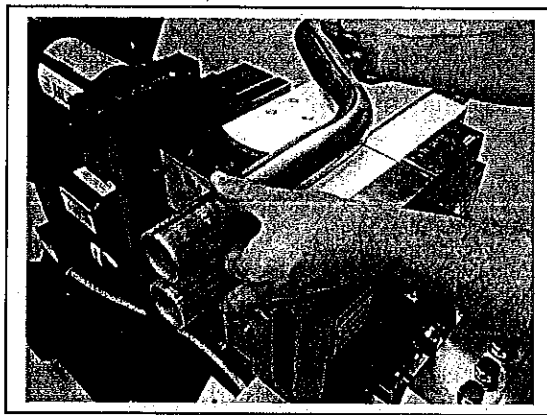

4. Extend the tubing out the left side of the bender, so it matches in length with the master pattern. Secure the tubing. (See Figure 9-1)

If the left end of the tubing does not fill the back shoe, extend the tubing to the left until it does. Mark the first bend on the tubing where it meets the center of the back shoes.

5. Measure the tubing from the end of the tube to the center of the back shoes. This is the measurement to the first bend and should be recorded on the first line of a blank program card on the first line of tubing called the "CENTER LINE MARK". (See Figure 9-2)

FIGURE 9-2

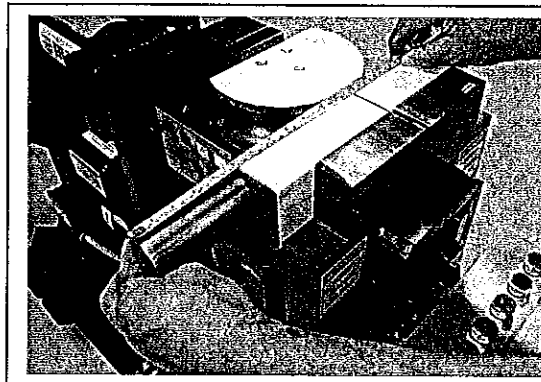

6. Place the rotation dial over the far right end of the tubing, so the numbered side faces the bender. Secure it in place when the indicator points to zero degrees. This reading is the rotation of the tubing for each particular bend and should be recorded on the second line of tubing called "Rotation In Degrees" on the program card. The first bend is always 0 degrees.

FIGURE 9-3

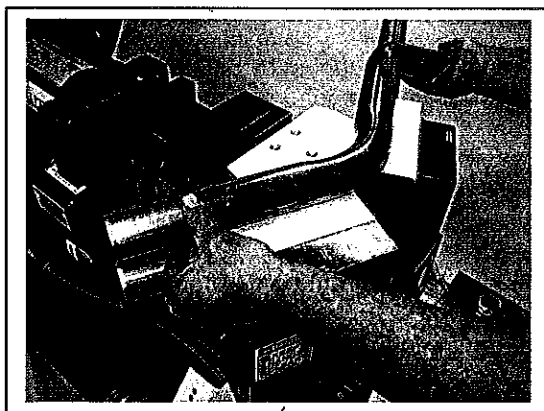

7. You are now ready to make your first bend. Place the first bend of the master pattern on the top of the back shoes or against the back side of the gates. Gradually extend the dies, opening the gates. Continue bending until the gates are parallel, or open flush, with the first bend of the master pattern. (See Figure 9-3)

8. Look at the Depth-of-Bend gauge on the left side of the bender. This is the depth of the first bend. Record this degree reading on the third line of the program card under "Depth of Bend".

9. Release the tubing and feed it left through the dies. Place the pattern on top of the back shoes. Line up the center of the second bend of the master pattern with the center of the back gates. Be sure that the bend of the master pattern lies flat on top of the dies.

FIGURE 9-4

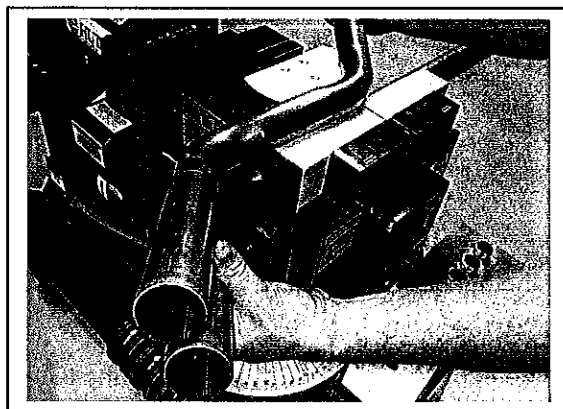

10. Line up the first bend of the new pipe with the first bend of the master pattern and rotate the new pipe until it lies parallel with the master pattern. Be sure the pattern lies flat on the dies with the bend centered. Close the dies to secure the tubing.

FIGURE 9-5

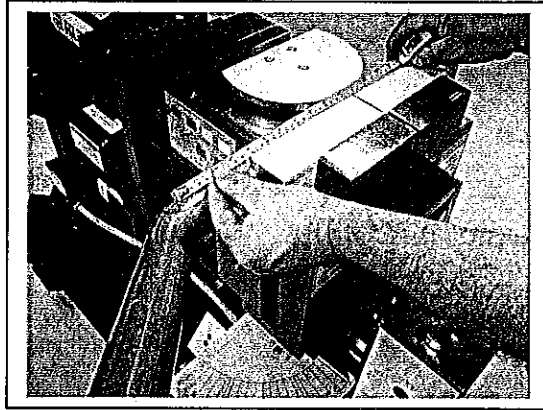

11. Your second bend is now correctly located. The measurement for the second bend should now be taken. Since bent tubing is difficult to measure, it is best to measure from the center of the first bend (between the back shoe die marks) to the center of the second bend (between the back shoes). This measurement is added to the measurement of the first bend and recorded on the first line on the program card. (See Figure 9-5)

12. Look at the rotation dial and take the reading of the tubing rotation for the second bend. This reading is recorded on the second line on the program card.

FIGURE 9-6

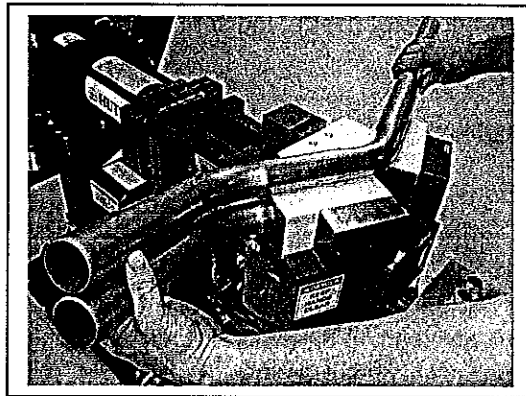

13. You are ready to make the second bend. Place the second bend of the master pattern on the back shoes or against the gates and gradually make your bend until the gates are parallel, or open flush, with the second bend of the pattern. (See Figure 9-6)

14. When the above is accomplished, take the reading from the Depth-of-Bend gauge and record it on the third line on the program card.

15. Continue to make the necessary bends following the steps from step 9. When all the bends are completed, perform the needed end finishing and measure the cutoff length. Note this information on the program card.

10. SWAGING AND EXPANDING

INTRODUCTION

FIGURE 10-1

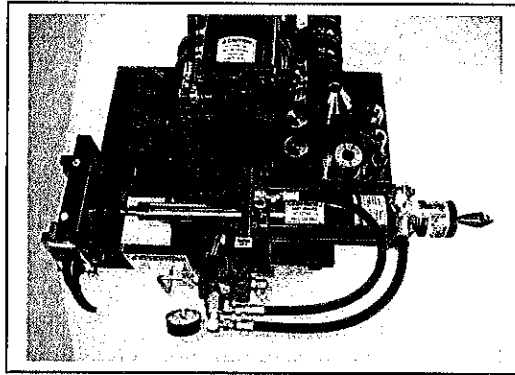

The attachment mounted on the rear of the bender is a Swager/Expander. It expands on one end and swages on the other. (See Figure 10-1)

The Swager/Expander unit will end-finish all pipes to original equipment specifications. This attachment is controlled manually by the operator at all times.

You CANNOT bend tubing and use the swager/expander at the same time.

CAUTION!

Safety is a **MUST** when using the swager/expander due to the high pressure used by this unit.

CAUTION!

When swaging or expanding, always lubricate tooling.

SWAGING OPERATIONS

After the tubing has been bent, it may be necessary to finish the end of the tubing. The swager portion of the swager/expander unit will make ball joints, flares, and slip joints. In addition, it will expand tubing (swage up) and reduce tubing (swage down). The following procedure is provided as a basic step-by-step process used to install the tooling and begin the swaging operation.

To produce a specific end finish, refer to the appropriate topic. (For example: to produce a flare, read the basic swaging operation, then read the operation of the topic "Flare".)

To begin basic operation, proceed as follows:

1. Turn the machine on.
2. Depress the swager control valve handle and extend the cylinder shaft (A) into the swager box approximately three inches. (See Figure 10-2)

Figure 10-2

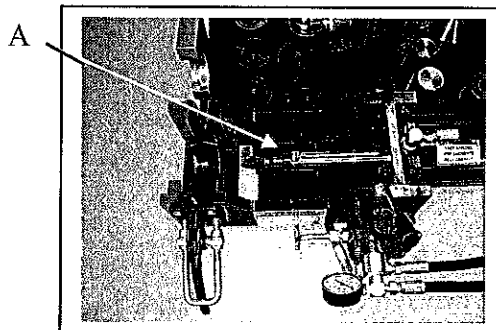

3. TURN THE MACHINE OFF.

4. Install the required tool, per tubing size or specification, onto the twist lock stud on the end of the cylinder shaft.

5. Install one half of a collet set in the collet closer, threads facing up.

NOTE: Always use the correct O.D. size collet to match the O.D. tube size.

6. Insert the end of the tubing at least three inches from the inside edge of the half collet.

7. Install the other half of the collet over the tubing and close the collet holder.

8. Secure the collet clamp in the down position.

9. Turn the machine on.

10. Slowly, while tapping the swager control handle, move the cylinder shaft with the tooling into the end of the tube.

11. See appropriate topic on specific tooling being used.

12. After tubing has been shaped and the cylinder shaft has been retracted, **turn off the machine.**

13. Raise the collet closer handle. The collet will release and separate from the tubing.

NOTE: Should the collets not release from the tubing, use a screwdriver to pry them apart.

WARNING!

Do not beat the collets on the bender.

CAUTION!

Always remove the tooling from the swager box after each usage to avoid damage when expanding on the expander side.

14. Remove the tooling and return it to the storage rack.

REDUCE SWAGE (SWAGE DOWN)

To reduce swage (reduce the outside diameter of the tubing) proceed as follows:

1. Select and install the proper collet set tooling and reducing die. (See Figure 10-3)

FIGURE 10-3

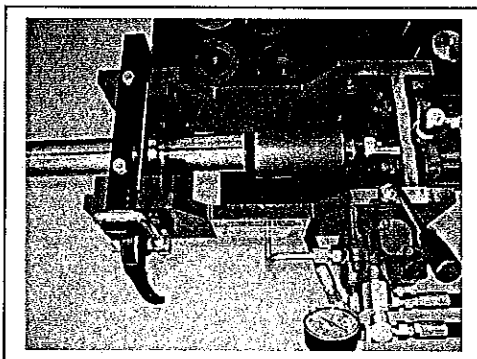

2. Follow steps 1 through 10 of topic "Swaging Operations".

3. Move the cylinder forward slowly until the tool is over the tube end. Continue to move the shaft until the tube has been formed.

4. Retract the cylinder shaft and tool. (See figure 10-4)

FIGURE 10-4

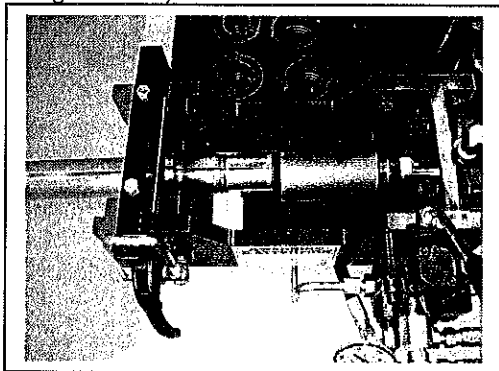

5. Follow steps 12,13 and 14 of topic "Swaging Operations".

INTERNAL SWAGE (SWAGE UP)

To internal swage (enlarge the outside diameter of the tubing), proceed as follows:

1. Select and install the proper collet set tooling and swage die. (See Figure 10-5)

FIGURE 10-5

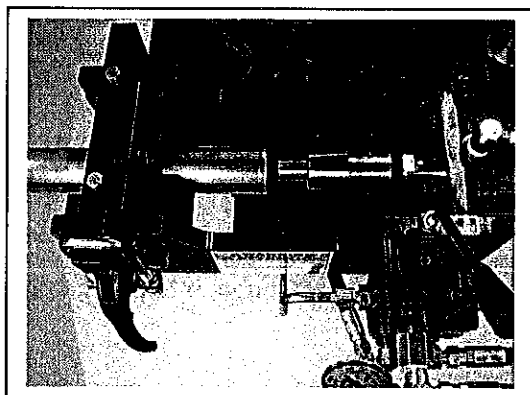

2. Follow steps 1 thru 10 of topic "Swaging Operations".

3. Move cylinder shaft forward slowly until the tool enters the tubing. Continue to move the shaft forward until the tool reaches the desired depth.

4. Retract the shaft and tool. (See Figure 10-6)

FIGURE 10-6

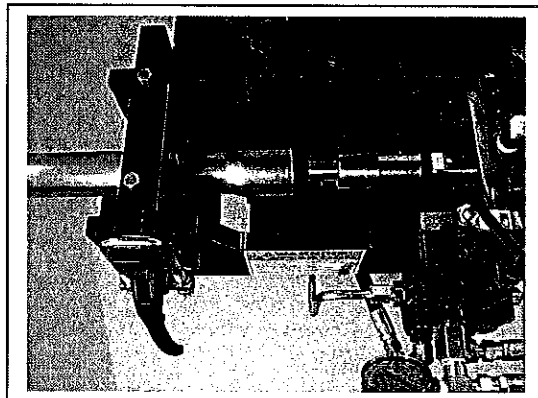

5. Follow steps 12 thru 14 of topic "Swaging Operations".

45° FLARE

It is necessary to install a flange over the tube prior to finishing the ends. To make a Flare or Flat Flare, the same tool is used – one side flares, the other side flattens.

The tooling required to make a flare are:

- Flaring Tool
- Collet Set (a pair in matching O.D. size)

To make a flare, proceed as follows: (See Figures 10-7 to 10-8)

FIGURE 10-7

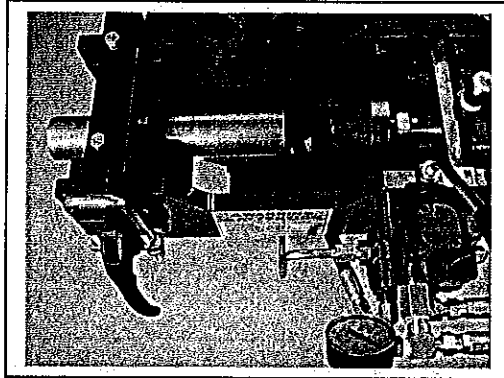
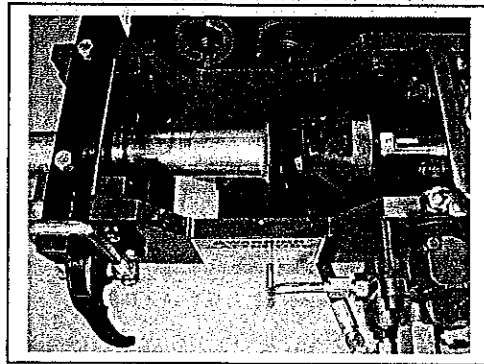

FIGURE 10-8



1. Insert the Flaring Tool on the die holder with the 45° flare facing the tube.
2. Follow steps 1 through 10 of topic "Swaging Operations".
3. When a desired flare is achieved, follow steps 12 through 14 of topic "Swaging Operations".

FLAT FLARE

It is necessary to install the flange over the tube prior to finishing the ends. To complete a Flat Flare, proceed as follows:

1. Complete the 45° flare process as described above.
2. After retracting the cylinder shaft, reverse the flaring tool and install it onto the die holder. Extend the shaft of the cylinder forward until the tool meets the flared tube. (See Figure 10-9)

FIGURE 10-9

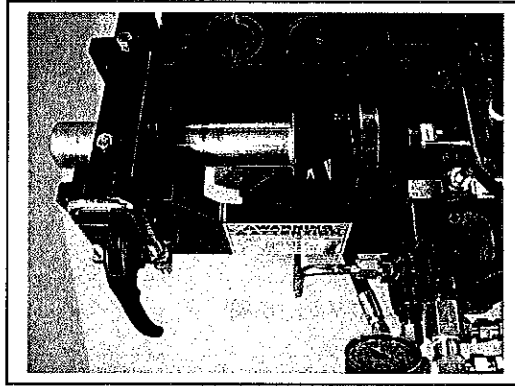

3. Slowly move the shaft forward until the flare forms a flat surface.
4. Follow steps 12 through 14 of topic "Swaging Operations".

FEMALE BALL SOCKET

It is necessary to install a flange over the tube prior to finishing the ends. To make a Female Ball Socket, proceed as follows:

FIGURE 10-10

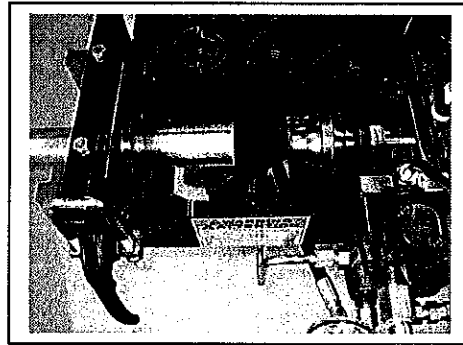

1. Install the Female Ball Tool on the die holder. (The tool is reversible for another size.) (See Figure 10-10)
2. Follow steps 1 through 10 of topic "Swaging Operations".
3. Insert the tool slowly into the end of the tube until the socket is formed. The tubing will meet flush with the stop on the tool. (See figure 10-11)

FIGURE 10-11

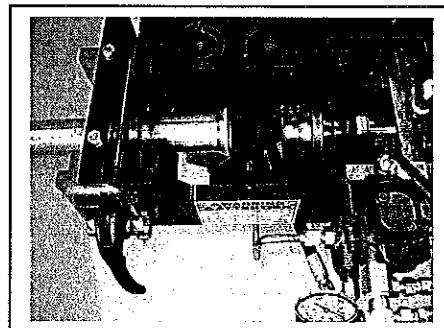

4. Follow steps 12 through 14 of topic "Swaging Operations".

FLARE FLANGE – for manifold gasket

It is necessary to install the flange over the tube prior to finishing the end. Certain finishing applications require a round manifold gasket. To make this application it is necessary to use a scrap piece of tubing, approximately 1 ½" long, in the next smaller size tube. This tubing scrap, or nipple, will be inserted into the end of the tube. It should be expanded to an O.D. size that will just be slightly larger than the I.D. size of the tube to be formed. (See topic "Expanding Operations") The tooling required to make a Flare Flange are:

- Flaring Tool
- Collet Set (pair in matching O.D. size)

To make Flare Flange, proceed as follows:

1. Follow steps 1 through 10 of topic "Swaging Operations".

FIGURE 10-12

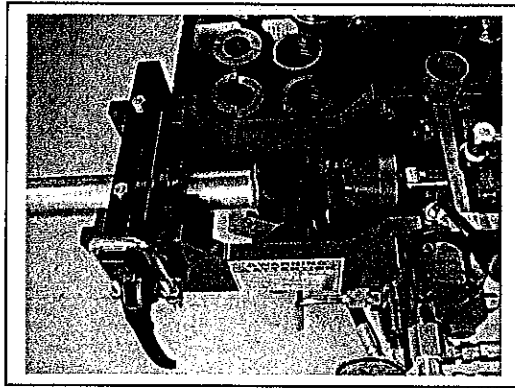

2. Insert the Flaring Tool on the die holder with the 45° facing the end of the tube.
3. Slowly insert the tool into the end of the tube forming a 45° flare. (See topic 45° FLARE)
4. Retract the cylinder shaft and tool. Reverse the tool on the die holder so the flat side is facing the tube end.
5. Insert (by hand) the scrap piece nipple into the end of the flared end of the tube. The nipple will hold itself in place. (See Figure 10-13)

FIGURE 10-13

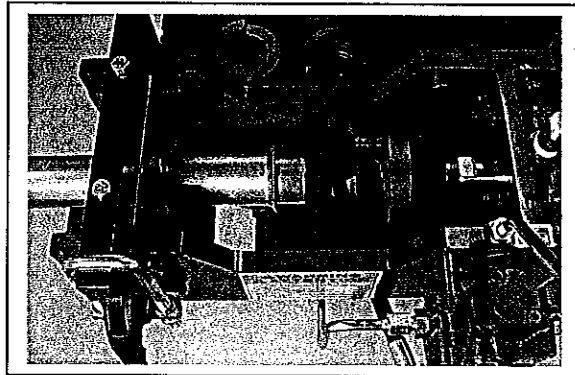

6. Remove your hand from the swager box.

WARNING!

NEVER OPERATE THE SWAGER/EXPANDER WITH YOUR HAND IN THE SWAGE BOX!

7. Slowly move the tool forward forcing the nipple into the tube until ½" protrudes beyond the end of the tube. This forms the seat for the round gasket. (See Figure 10-14)

FIGURE 10-14

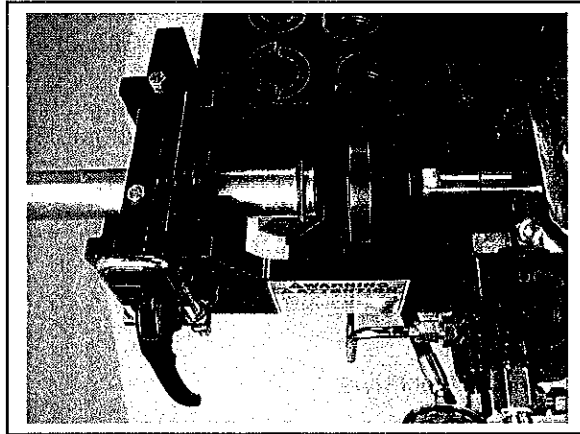

8. Follow steps 12 through 14 of topic "Swaging Operations".

EXPANDING OPERATIONS

The 3012 comes equipped with an Expanding Kit. The Expanding Kit comes calibrated from the factory. It uses segmented tooling to form end finishes on the end of tubes. An Expanding Chart Decal is on the machine to show settings that correspond with the Sizing Decal on the Adjustable Collar. Select the type of tooling to be used. Look on the Setting Chart for the setting desired with the tooling. Set the Adjustable Collar to the appropriate setting for the end finish. (See Figures 10-15 and 10-16)

FIGURE 10-15

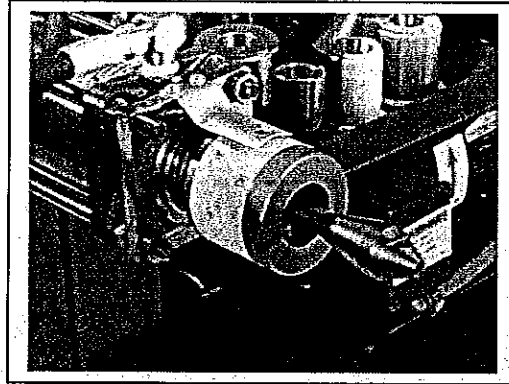

FIGURE 10-16

SETTING CHART																	
INSTRUCTIONS:																	
(A) SELECT TOOL USING COLOR CODE CHART																	
(B) DETERMINE CORRECT SETTING NUMBER FROM CHART BELOW																	
(C) SLIP TOOL OVER ARBOR HEAD AND TURN ADJUSTING COLLAR UNTIL THE SELECTED SETTING NUMBER IS CENTERED IN THE SIGHT GAUGE																	
EXPANDERS												FLARES		MALE BUCK BALL		FEMALE BUCK BALL	
ID		OD		FLARES		MALE BUCK BALL		FEMALE BUCK BALL		FLARES		MALE BUCK BALL		FEMALE BUCK BALL			
2 1/4	1 1/2	1 1/4	1 1/8	2	1 3/8	2 1/4	1 1/2	1 1/4	1 1/8	2 1/4	1 1/2	1 1/4	1 1/8	2 1/4	1 1/2		
2 1/2	1 3/4	1 3/8	1 1/4	2 1/8	1 3/4	2 1/2	1 3/4	1 3/8	1 1/4	2 1/2	1 3/4	1 3/8	1 1/4	2 1/2	1 3/4		
2 3/4	2	1 7/8	1 3/4	2 1/4	2	2 3/4	2	1 7/8	1 3/4	2 3/4	2	1 7/8	1 3/4	2 3/4	2		
3	2 1/4	2 1/8	1 7/8	2 3/8	2 1/4	3	2 1/4	2 1/8	1 7/8	3	2 1/4	2 1/8	1 7/8	3	2 1/4		
3 1/4	2 3/4	2 1/4	2 1/8	2 3/4	2 3/8	3 1/4	2 3/4	2 1/4	2 1/8	3 1/4	2 3/4	2 1/4	2 1/8	3 1/4	2 3/4		
3 1/2	3	2 3/4	2 1/4	3	2 3/4	3 1/2	3	2 3/4	2 1/4	3 1/2	3	2 3/4	2 1/4	3 1/2	3		
3 3/4	3 1/4	3	2 3/4	3 1/8	3 1/4	3 3/4	3 1/4	3	2 3/4	3 3/4	3 1/4	3	2 3/4	3 3/4	3 1/4		
4	3 1/2	3 1/8	2 3/4	3 1/4	3 1/8	4	3 1/2	3 1/8	2 3/4	4	3 1/2	3 1/8	2 3/4	4	3 1/2		

• USE 1 1/2" - 2" TOOL

SETTING NUMBERS

1 2 3 4 5 6 7 8 9 10 11 12 13 14 15 16

USING EXPANDING TOOLS

The following procedure is provided as a basic step-by-step process to install tooling and begin the expanding operation. To produce a specific end finish, it will be necessary to refer to the appropriate topic. For example: to produce a flare, read the basic operations first then read the steps of the topic "Flare".

To begin the basic operations, proceed as follows:

1. Turn the machine on.
2. Lift the swager control valve handle and extend the cylinder shaft outward approximately 6".
3. Be certain the arbor is always secure (snug with the jam nut) to the cylinder shaft.
4. Grease the arbor thoroughly.
5. Install the appropriate segment set onto the arbor by simply forcing it over the end of the arbor.

WARNING!

ALWAYS ADJUST THE ADJUSTABLE COLLAR FOR EACH EXPANSION. OVER EXTENDING THE COLLAR WILL CAUSE DAMAGE!

6. Choose the setting of the Adjustable Collar for the desired expansion. Use the Setting Chart to find the desired end finish dimension then look directly down at the base of the chart to see the correct number setting that will be placed in the gun sight of the adjustable collar. Move the adjustable collar so that the correct number is in the sight hole.

CAUTION!

Always use the correct segment set for the desired expansion. Failure to do so will result in damage or breakage.

7. Place the tube halfway onto the segment set and tap the handle to start expanding. This will remove any burrs and straighten the end of the tube from any under sizing on the tube end.
8. Extend the arbor and segment set to relax the segment. Slide the end of the tube to the base of the segment set.
9. Tap the control handle down to start the expanding. Expand the tube half way to the desired expansion. Relax the segment set and slightly rotate the tube. Hold, or tap, the control handle down to reach the desired expansion. Relax the segment set and slightly rotate the tube again. Hold the handle of the control valve down and completely expand the tube again. This process will keep the tube from "sticking" and make the expansion smooth and round. (See Figure 10-18)

FIGURE 10-18

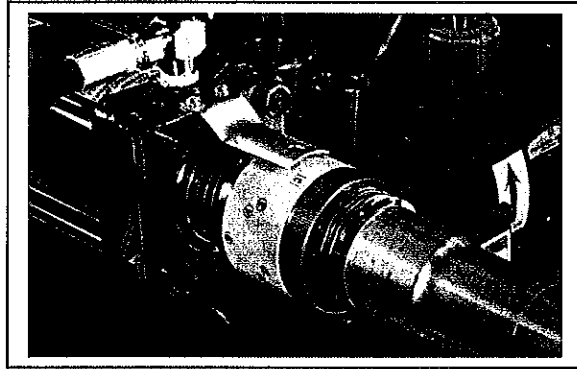

10. Segment sets can be removed from the arbor without disassembling the tool. Simply pull the segment set off the arbor.

WARNING!

When performing an end finish other than a calibrated setting, always begin with the adjustable collar located inward and advance it to make the desired end finish. If the collar is left fully extended, prolong use will distort the collar threads, and the collar will seize up. This will cause damage and breakage.

FLARING SEGMENT SET

With a Flaring Segment Set, flares from 1 ½" to, and including, 2 ½" can be completed quickly using the expander. To produce a flare, proceed as follows:

1. Install the arbor being sure it is securely tightened onto the cylinder shaft.
2. Slide the Flaring Segment Set over the arbor. (See Figure 10-19)

FIGURE 10-19

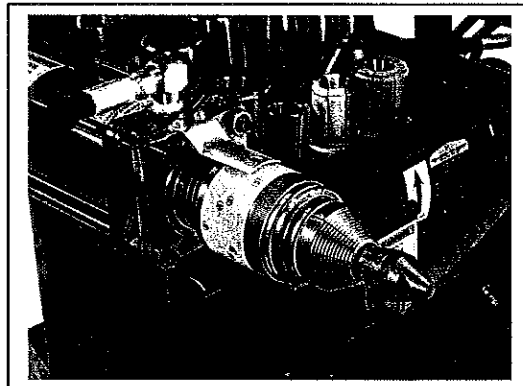

3. Place the tubing over the arbor and segment set, but DO NOT place the end of the tubing past the last step (tooth) on the segment. (See Figure 10-20)

FIGURE 10-20

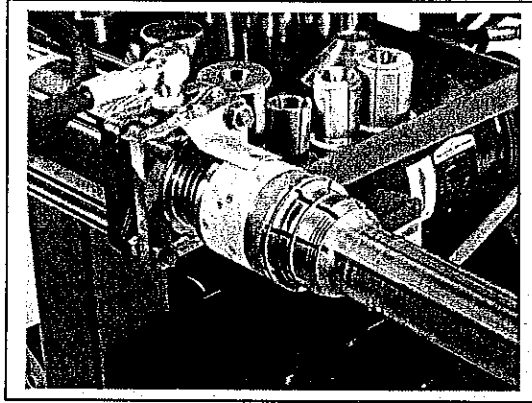

4. Depress the control handle and rotate the tubing to produce the desired flare.

NOTE: Smaller diameters should be gradually worked up onto the Segment Set.

BALL JOINT SEGMENT SETS

Ball Joint Segment Sets are used to produce male and female joints on tubing from 2" to, and including, 3". The joints can be made quickly using the expander. To produce a ball joint, proceed as follows:

1. Install the arbor being sure it is secured tightly to the cylinder shaft.
2. Slide the Ball Joint Segment Set over the arbor. (See Figure 10-21)

FIGURE 10-21

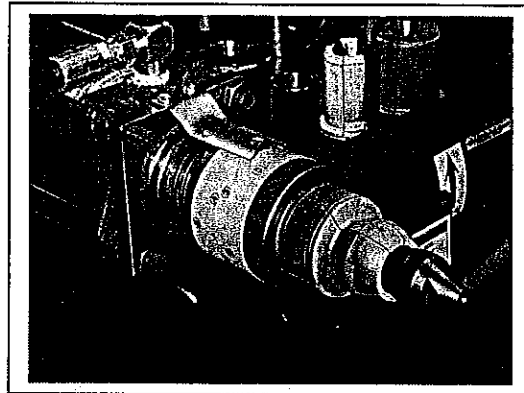

3. To make the male ball joint place the tubing over the arbor and the segment set until the end of the tubing touches the base of the segment set.

4. Depress the control handle to form the ball, being careful not to distort the open end of the tubing. (See Figure 10-22)

FIGURE 10-22

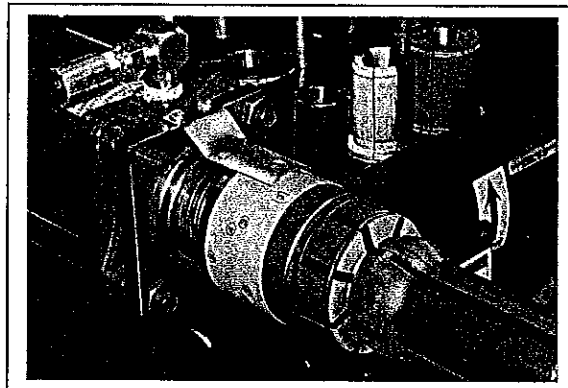

5. To make a female ball joint, place the tubing over the arbor and segment set until the end of the tubing is at the groove on the ball.

6. Depress the control handle and flare the end of the tubing to fit the mating ball joint. (See Figure 10-23)

Figure 10-23

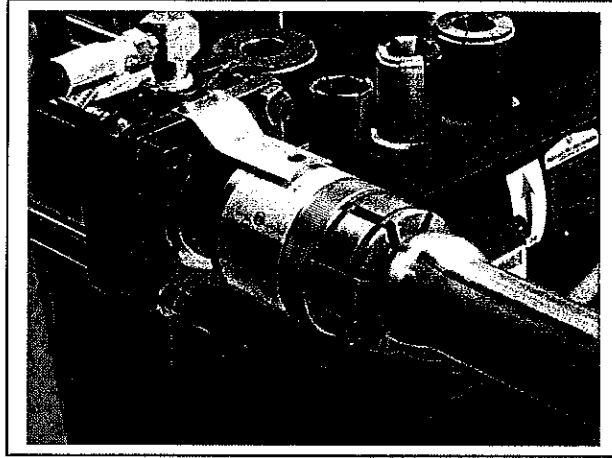

11. PERIODIC MAINTENANCE

INTRODUCTION

The following maintenance should be performed regularly to ensure the long life and proper performance of your bender.

DAILY

Clean and lubricate the following:

1. Guide Rails – Lubricate with grease. Remove any burrs and debris.
2. Sled – Keep the sled clean at all times. Never move the sled without bending die in place.
3. Verify Pressure Settings: 2,900 – 3,000 PSI at the Swager/Expander and 600 – 700 PSI on the sequence valve at the bending end.

TO CHANGE THE PRESSURE SETTING BENDING PRESSURE

1. Install a 5" radius die and appropriate back shoes on the bender.
2. Turn on the bender.
3. Advance until the dies are engaged.
4. Read the pressure from the gauge of the sequence valve. Normal bending pressure for tubing is between 500 – 700 PSI. The pressure can only be read as the dies are in the motion of bending. No tubing is required for this. **NEVER exceed 1,000 PSI.**
5. If the pressure is incorrect, adjust the pressure using the pressure regulator dial knob of the sequence valve. Turning the knob clockwise (inward) increases the pressure. Turning the knob counter clockwise (outward) decreases the pressure. (See Figure 11-1)

FIGURE 11-1

CLOCKWISE – INCREASES

COUNTERCLOCKWISE -
DECREASES

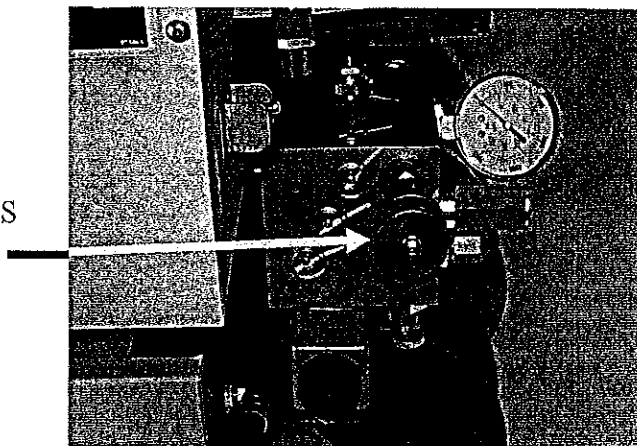

If your pressure gauge does not read zero when the dies are disengaged, replace the gauge.

SWAGING/EXPANDING PRESSURE

1. Turn on the bender.

WARNING!

Remove any tooling from the swage box.

2. Press swager control handle down until the cylinder extends completely into the swage box (to the left). The pressure can only be read as the cylinder is completely engaged. When the pressure is relieved from the cylinder, the gauge should read 0 psi.

WARNING!

Never allow swaging pressure to exceed 3,000 psi.

3. Read the pressure on the gauge. Pressure should be approximately 3,000 psi. Pressure should not exceed 3,000 psi. **If pressure exceeds 3,000 psi, release the valve lever immediately; pull the valve lever up to relieve pressure and reset the valve to a lower pressure.**

FIGURE 11-2

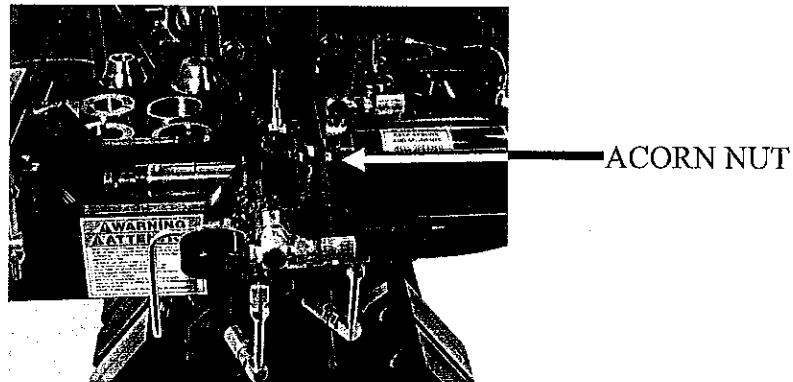

4. If the pressure is incorrect, remove the acorn nut and loosen the jam nut on the swage valve pressure stem. With an allen wrench, turn the pressure stem to adjust the pressure. Turning it clockwise will increase the pressure. Turning it counterclockwise will decrease the pressure. Tighten the jam nut and replace the acorn nut to secure the pressure adjusting stem. (See Figure 11-2)
5. After the pressure setting has been adjusted, recheck the pressure setting.

TWICE-A-WEEK AUTOMATIC DEPTH-OF-BEND CALIBRATION

Check the alignment of the Depth-of-Bend Limit Switch.

1. Using a 5" radius die and appropriate back shoes, engage the dies and extend the ram die until the pointer on the depth-of-bend plate reads 90 degrees.
2. Using a carpenter's square, check the alignment of the back gates to ensure a true 90-degree reading.

Note: Different materials have different amounts of spring-back.

The depth-of-bend plate and adjustable pointer are located under the right side gate. Using a carpenter's square to check this calibration, proceed as follows:

1. Align the gates at 90 degrees.
2. Turn the bender off.

FIGURE 11-3

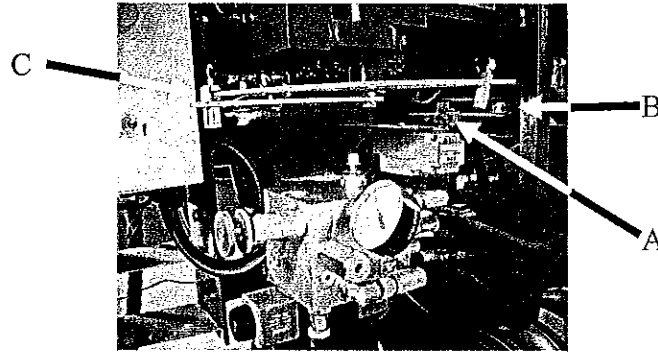

3. Move the adjustable pointer slowly past the 90-degree mark on the Depth-of-Bend Plate. As the pointer crosses 90 degrees, you should hear the limit switch trip (click). If the limit switch does not trip at 90 degrees, perform the following steps: (See FIGURE 11-3)

- A. Loosen the nut or screw holding the roller arm to the limit switch (key A in FIGURE 11-3).
- B. Move the arm (Key B in FIGURE 11-3).
- C. Tighten the nut or screw.
- D. Move the adjustable pointer across the 90-degree mark (key C in FIGURE 11-3). If the limit switch does not trip at 90 degrees, repeat steps A through D.

4. Turn the bender on and move the pointer across the 90-degree mark. As the pointer crosses the 90-degree mark, the gates should begin to close.

RETURN TO HOME POSITION CALIBRATION

FIGURE 11-4

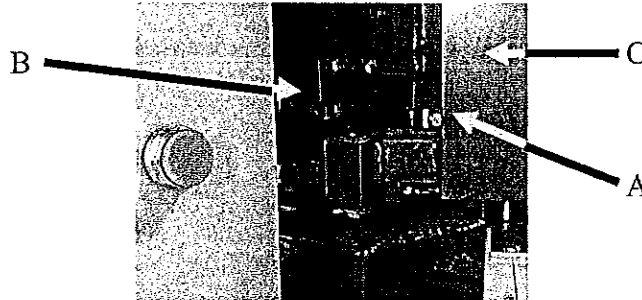

The Home Position Switch (FIGURE 11-4) calibration should rarely be necessary. The gate bolt (A) triggers the switch (B) exactly when the gates (C) close. To adjust the bolt, loosen the locknut and move the bolt in or out, then lock down the locknut.

CAUTION!

Do not overextend the bolt and exert pressure on the switch.

If the switch is no longer being tripped, perhaps an object or dirt build-up is stopping the gate from closing all the way. Always keep the bending area clean.

Manual Depth-of-Bend Calibration

You may notice that the degree pointer connected to the left side gate may read 1 degree below zero on the depth-of-bend plate. This is set at the factory to compensate for the "spring back" in tubing and should be checked occasionally as follows:

1. Using a 5" radius die and appropriate back shoes, engage the dies and extend the ram die until the pointer on the depth-of-bend plate reads 90 degrees.
2. Using a carpenter's square, check the alignment of the back gates to ensure a true 90-degree reading.

3. Set the pointer to 90 degrees by tapping gently on the depth-of-bend plate or loosening the bolts and nuts.

WEEKLY

CAUTION!

Do not use strong solvents to clean dirt from the bender. Solvents may damage some components.

1. Use a mild detergent to remove all dirt build-up from the bender. Ensure there is no dirt built up between the gate and the guide plate. Also, check for dirt at the top of the gates and the gate pins. Dirt can cause excessive wear.

CAUTION!

Do not use an air hose near the control box.

2. Clean dirt and oil from the bending dies and remove any burrs.
3. Check the cylinder shafts for nicks or burrs and remove them using emery cloth.
4. Inspect the segment sets for cracks or damage. Replace if necessary.

CAUTION!

Hose fittings are made of soft metal. Overtightening may damage the fittings and cause leaks.

5. Inspect hoses and fittings for leaks. Tighten as required.
6. Check for bolts or nuts that may have loosened.
7. Inspect all the electrical components, i.e. plug, receptacle, cord, knee pedal, conduit, etc. Replace any damaged electrical components immediately. (See section 14 BENDER REPAIR)
8. Grease the 4 grease fittings as shown in FIGURE 11-5 using a medium-weight, all-purpose grease.

FIGURE 11-5

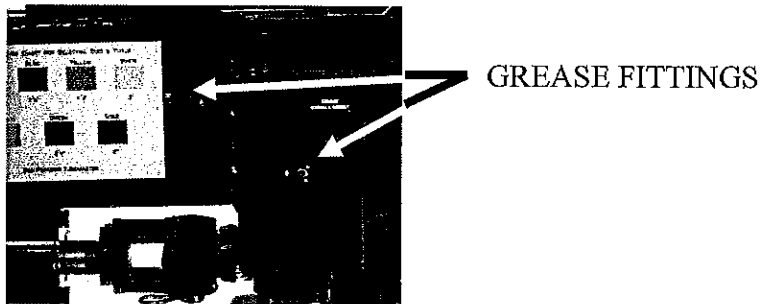

9. Ensure that the bolts in the guide rails are tight.
10. Check that the depth-of-bend plate(s) are tight. If a plate is loose, tighten it, so it is parallel to the bender's main frame. Recalibrate the bender using the procedure explained in the section titled "Depth-of-Bend Calibration."

MONTHLY

Perform the following maintenance monthly:

1. Check the oil level of the bender. The bender contains approximately 4 gallons of hydraulic fluid. To check the oil level:
 - A. Reduce the pressure on the sequence valve to 0 psi.
 - B. Using a 5" radius die and back shoes, advance the ram die until the main cylinder is fully extended and stop the bender.
 - C. Visually check the oil level in the filler elbow located on the left side of the machine under the depth-of-bend indicator plate. Oil should appear in the filler elbow or can be felt by inserting your fingertip into the elbow.

NOTE: Do not retract the dies before adding oil.

D. If oil cannot be seen or felt, add oil to the filler elbow until it is visible.

NOTE: If oil must be added to the system frequently, check for leaks.

You can use any 10 medium weight, mineral-based hydraulic fluid with non-foaming additive. The oil should have an **ISO 46 Grade** rating.

2. Clean all tooling to remove old grease, nicks and burrs. A light application of lubricating oil is recommended for bending dies and back shoes. Swage and expanding tools should be lightly greased.

FIGURE 11-6

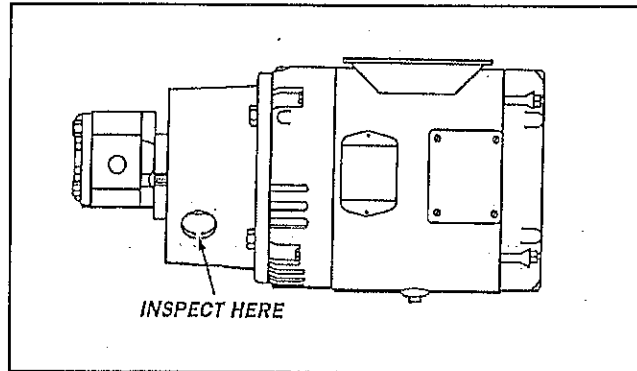

3. Inspect the coupling between the pump and the motor to ensure the allen set screws have not loosened. (See FIGURE 11-6)

Make sure the two halves of the coupling are separated by the rubber spider.

4. Check and tighten any loose connections in the hose leading from the reservoir to the pump.

NOTE: A loose connection on this hose may not always show a leak, but it will suck air and cause aeration in the system, causing the bender to react with uneven operation.

12. TROUBLESHOOTING

INTRODUCTION

The troubleshooting procedures charted on the following pages contain the problem, the possible cause, and the corrective action to be taken.

There are two basic sections: Electrical Troubleshooting and Hydraulic Troubleshooting. After identifying the problem, proceed with the appropriate corrective action. The chart is organized from the most simple to the more difficult procedures. Be certain the person performing the work has the necessary ability and skills. Observe all safety rules when working on the bender.

Call HUTH EQUIPMENT for assistance at 1-800-558-7808.

WARNING!

Turn OFF the bender and LOCK OUT/TAG OUT power before servicing.

ELECTRICAL TROUBLESHOOTING

PROBLEM	POSSIBLE CAUSE	CORRECTIVE ACTION	
Motor does not run.	Circuit breaker is off.	Turn breaker on.	
	Incorrect wiring.	Check voltage supply, phase and wiring.	
	Poor connection at plug.	Check wiring.	
	Cut in power cord.	Check and replace at once.	
	Defective start/stop switch.	Test and replace if needed.	
	Motor defective.	Test motor – check with local electrical motor supplier for service center. Replace if needed.	
	Overload at contactor tripped.	Reset overload.	
Motor smokes.	Internal wiring has become disconnected.	Check wiring at contactor and buttons.	
	Centrifugal switch sticking in open position.	Remove motor – service at local service center.	
Motor shuts off.	Overload safety turning motor off.	Reset overload switch and restart. If problem persists, check wiring for short circuit.	
	Overload amp setting too low.	Check to determine if motor is overloaded. Compare to amp draw of motor on motor's specification tag.	
	A poor connection at plug or a cut in the power cord.	Repair or replace.	
	Motor starter defective.	Replace starter.	
	Motor capacitors defective.	Replace.	
	Bender emits shocks.	Lost ground connection.	Check plug to receptacle fit.
			Check plug wiring.
		Check cord for damage.	
Buttons do not activate functions.		Check the ground connection at the control box. The bender or tubing being bent must not come in contact with any other object.	
	Directional valve problem.	Check wiring.	
		Check for bad coils.	
		See "Power at Swager Control Valve But Not at the Main Cylinder" in Hydraulics Troubleshooting Section.	
	Wiring problem.	Check wiring and connections.	
	Contact block loose.	Re-secure block to back of button.	

HYDRAULIC TROUBLE SHOOTING

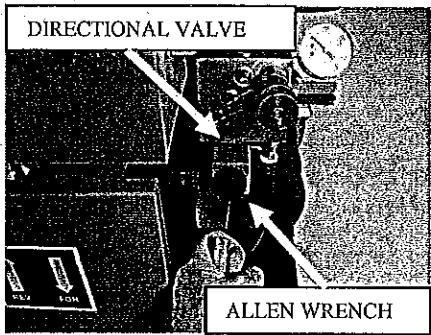
PROBLEM	POSSIBLE CAUSE	CORRECTIVE ACTION
Loss of power on either end of bender.	Low pressure.	Adjust pressure. See Section 11, Periodic Maintenance.
	Pump not functioning properly.	Key sheared on coupling/coupling loose. Test pump. See topic "Loss of Power Entire Machine".
	Bender low on oil.	Fill tank.
	Hose from tank to pump loose, sucking air.	Secure hose.
	Aeration of oil.	Check all hoses and fitting. Stop all leaks.
	Filter/Strainer in front leg clogged.	Remove, clean and replace.
Bender stops bending after a few degrees or swaging cannot be done; motor bogs down.	Swager control valve leaks internally – will not build pressure.	Check oil flow to valve. Replace valve.
	Low voltage	Check fuse. Check that bender has its own breaker. Check incoming voltage. Ensure plug and receptacle make good connections. Check cord.
	Bender low on oil.	Fill tank.
	Filter/Strainer in front leg clogged.	Remove, clean and replace.
Directional valve chatters.	Back shoe pressure too high.	Lower back pressure.
	Low voltage.	Check fuse. Check that the bender is on its own circuit breaker. Check incoming voltage. Ensure plug and receptacle make good connections. Check cord. Check internal wiring and conduit for breaks.
Power at the swager control valve, but not at the main cylinder.	Directional valve not operating properly. FIGURE 12-1 	Operate valve manually by: Using an allen wrench, push the small button on the end of the coil. (See Figure 12-1) The left coil retracts the cylinder. The right coil extends the cylinder. The main cylinder should move. If the button will not move, the valve is defective. Replace the valve. See Section 13 – Machine Repair "Control Valve Replacement". If manual operation is possible, check for voltage at coil of valve. If voltage is present, the coil is bad, replace valve. See Section 13 – Machine Repair "Control Valve Replacement".
	Seals in main cylinder are bad.	With a 5" radius die in place, extend the main cylinder forward as far as possible. Turn the machine off. Remove the hose from the shaft end of the cylinder at the end farthest away from the cylinder. Place the end of the hose in a clean bucket. Turn the machine on. Press the forward button. If the seals are good, no oil will come out of the hose.
	Sequence valve PSI set too high.	See Section 11 – Periodic Maintenance.
	Swager control valve leaking internally.	Replace valve.
	Sequence valve bypassing internally.	Replace valve.

Main cylinder keeps moving until it bottoms out after the button or lever is released.	Directional valve spring is broken.	Replace valve. See Section 13 – Machine Repair. See corrective action under “Control Valve Replacement”
	Dirt in directional valve prevents spring return to neutral center position.	Replace valve. See Section 13 – Machine Repair “Control Valve Replacement”. Override valve. See Figure 12-1
	Limit switch	Determine if the limit switch has been tripped. If it hasn't, readjust the switch. See “Automatic Calibration,” “Home Position Calibration”. Section 11
	Electric button	The button may not have released. Clean and check contacts.
	Knee pedal control	Check controls and wiring.
	Loose pointer	Secure pointer.
	Depth-of-bend plate and pointer do not travel horizontally.	Adjust plate and pointer. See “Automatic Depth-Of-Bend Calibration” in “Periodic Maintenance”.
Directional control valve chatters and will not engage properly.	Low voltage.	Check voltage and machine wiring including plug and receptacle.
	Coil is bad.	See Possible Cause under “Directional valve not operating properly”.
Directional control valve clicks on return of main cylinder.	Low voltage.	Check voltage and machine wiring including plug and receptacle.
	Coil is bad.	See Possible Cause under “Directional valve not operating properly”.
After autobend main cylinder fully retracts.	Home position switch is not calibrated.	See “Return To Home Position Calibration” in Periodic Maintenance, Section 11.
	Timing relay loose or bad.	Secure or test manually.
Dies drift after completion of bend.	Directional control valve is defective or dirty.	Clean and test the directional control valve. Replace if necessary. See Figure 12-1
	Seals worn in side cylinders.	See “Gates move slowly”.
	Sequence valve worn.	Replace valve.
	Main cylinder seals are bad.	Check seals. See “Power at Swager Control but not at Main Cylinder”.
Directional or swager valve leaks.	Valve body is cracked.	Inspect valve and replace if cracked.
Hydraulic pressure is low.	Improper adjustment.	Adjust pressure. See Section 11 – Periodic Maintenance, “Operating Pressure Test”.
	Connectors on intake hose from reservoir to pump are loose. Air leaking in.	Tighten connections.
Hydraulic pressure drops.	Pump defective.	Test pump. See problem “Loss of Power to Entire Machine”, Check coupler. Replace pump.
Hydraulic pump noisy.	Motor-to-pump coupler loose.	Tighten coupling.
	Key on motor or pump shaft is sheared.	Replace key. Inspect motor/pump shaft for damage. Replace coupling if damaged.
	Spider on coupling is damaged.	Replace coupling or spider.
	The pump is bad.	See “Loss of Hydraulic Power to Entire Machine”.
Pressure reads 3,000 PSI at swager but there is a loss of bending power.	Main cylinder seals are bad.	See “Power at Swager, Not at Main Cylinder”.
Hydraulics are “jumpy” or erratic.	Air in hydraulic system.	Ensure that all hoses and fittings are tight.

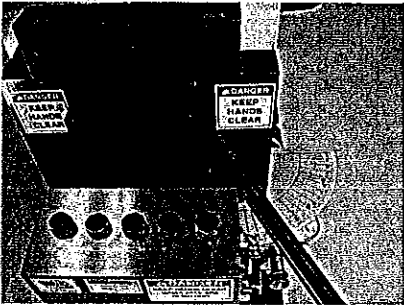
	Air in hydraulic pump.	Proceed as follows: 1. Top off oil level in reservoir with fresh oil. See Section 11 – Periodic Maintenance. 2. Run bender through its cycle several times until the entire system is purged of air bubbles.
	Oil in reservoir is low.	Add oil, See Section 11 – Periodic Maintenance.
Gates do not return correctly.	Pressure setting at sequence valve is incorrect.	Reset pressure. See Section 11 – Periodic Maintenance.
	Dirt or grease buildup on gate bearing pin.	Clean and lubricate using the following procedure: 1. Remove the depth of bend plate. 2. Remove the degree pointer. 3. Remove the clevis pin and move the cylinder out of the way. 4. Remove the snap pin from the gate bearing pin. 5. Press out bearing pin. 6. Remove gate. 7. Clean parts, lubricate and reassemble.
	Sequence valve out of adjustment.	See problem "Pipe Collapses".
	Air in system.	See "Hydraulics are "jumpy or erratic".
	Side cylinder seals are bad.	See "Gates move slowly".
Gates move slowly.	Pressure setting incorrect.	Adjust pressure. See Section 11 – Periodic Maintenance.
	Back pressure cylinder is worn. FIGURE 12-2 	Set sequence valve to 100 PSI. With the gates closed and power off, try to pry the gates open. See Figure 12-2. If the gates open, the seals in the back pressure cylinder are worn and should be replaced. Test seals. With a 5" radius die and matching back shoes (no tubing) extend the main cylinder forward as far as possible. Turn the machine off. Remove the hose from the rear of the back pressure cylinder at the sequence valve. Turn the machine on. Depress the forward button. If the seals are bad, oil will flow out of the hose.
Back pressure cylinder leaking.	Cylinder worn.	Replace seals. See Section 13 – Machine Repair.
Bender cannot complete bend. Motor running properly.	Pressure set too high. (Usually on larger diameter tubing)	Reduce pressure slowly while bending until the bender provides a good quality, even bend.
Pipe collapses.	Swager valve pressure setting is incorrect.	Adjust pressure. See Section 11 – Periodic Maintenance.
	Defective tubing.	Check diameter and wall thickness of tube. Attempt another bend on another piece of tubing.
	Buildup or caking of material on surface of bending dies.	Clean dies and lightly oil.
	Gauge of tubing too thin for diameter of tube.	Ensure that 2 ¼" tube and larger is at least 14 GA.

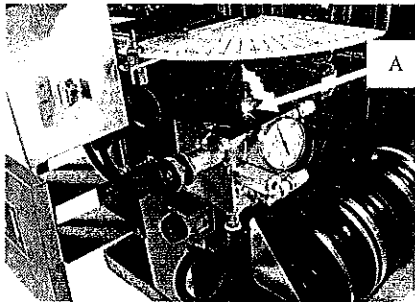
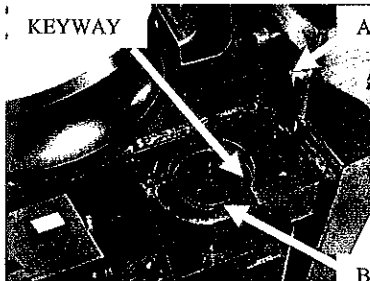
	<p>Setting on sequence valve is incorrect. (Travel time of sled and die extension and retraction should be the same). FIGURE 12-3</p> 	<p>If the extension and retraction times are not equal:</p> <ol style="list-style-type: none"> 1. Loosen the jam nut on the top of the sequence valve. 2. Using an allen wrench, turn the adjustment screw (A) on top of the valve. See Figure 12-3 3. When the extension and retraction speeds match, thighten the jam nut down and lock the adjustment screw in place.
	<p>Back Pressure cylinder is worn.</p>	<p>See problem "Gates move slowly".</p>
	<p>Gates not operating properly. FIGURE 12-4</p> 	<p>Check operation of gates:</p> <ol style="list-style-type: none"> 1. Place a 3" radius die on the sled and extend the main cylinder to open the gates. 2. Look at the pivot pins in the gates as the gates are opening. The gate (A) and the Pin (B) should turn at the same time. (See Figure 12-4) If the pins do not turn with the gates, the keyway is worn or sheared. The key must be replaced; and the pin, bushings, and gate bore inspected for damage. If either are badly scored, replace them.
	<p>Gates slip or tilt.</p>	<p>Remove the chains from the gates and move the gates by hand to check for play in the pivot. If play is significant, check bushings in the head block for wear. Replace if needed.</p>
	<p>Tooling is damaged.</p>	<p>Check tooling for damage. Replace damaged tooling.</p>
Segment set teeth break.	<p>Arbor wrong size or worn.</p>	<p>See Section 10 – Swaging/Expanding.</p>
	<p>Arbor needs lubrication.</p>	<p>Apply a thin coating of grease to the arbor and the face of the expanding cylinder.</p>
	<p>Adjustable collar is not being used correctly.</p>	<p>See Section 10 – Swaging/Expanding.</p>
Loss of hydraulic power to entire machine.	<p>Defective pump.</p>	<p>Hold down swager valve handle and look at the pressure reading at the end of the cylinder stroke. If the pressure decreases during the reading, replace the pump.</p>
	<p>Low oil.</p>	<p>Fill the oil tank. See Section 11 – Periodic Maintenance.</p>
	<p>Clogged filter/strainer.</p>	<p>Clean or replace the filter/strainer.</p>
	<p>Swager valve not set correctly.</p>	<p>See Section 11 – Periodic Maintenance.</p>
	<p>Swager valve bypassing internally.</p>	<p>Replace valve.</p>
Motor runs but pump does not develop pressure.	<p>Motor rotating in wrong direction. (3 phase only)</p>	<p>TURN OFF MOTOR IMMEDIATELY. Motor should be turning counterclockwise as seen when facing the pump. See Section 13 – Machine Repair</p>
	<p>Coupler between motor and pump is loose.</p>	<p>Tighten coupler. Check keyway. See Section 11 – Periodic Maintenance.</p>
	<p>Low on oil.</p>	<p>Check oil level. See Section 11 – Periodic Maintenance.</p>
	<p>Defective pump.</p>	<p>Test pump. See "Loss of Power to Entire Machine".</p>
	<p>Clogged filter/strainer.</p>	<p>Clean or replace filter/strainer.</p>

13. MACHINE REPAIR

GENERAL REPAIR

Calibration Decal Replacement

Should the Calibration Decal of the adjustable collar need to be replaced, proceed as follows:

1. Remove the old decal and clean the area.
2. Be sure the arbor is securely tightened to the cylinder shaft.
3. Place the 2" segment set (blue & white) on the arbor.
4. Expand a piece of 2" tubing just enough to insert another piece of 2" into it. (2.015")
5. Locate  of the calibration decal in the hole of the gun sight.
6. Secure the decal to the adjustable collar.

HYDRAULIC REPAIR

INTRODUCTION

The following hydraulic repair section contains step-by-step instructions for replacing major hydraulic components on your bender. Repair procedures not listed here should be left to qualified service personnel. If you are unfamiliar with hydraulic servicing, contact your distributor for professional service.

WARNING!

Serious injury can occur if hydraulic hoses are connected incorrectly. Pump damage may also occur. Always note the location of hydraulic hoses before removing components to ensure that the hose is connected properly during reassembly.

CONTROL VALVE REPLACEMENT

To replace control valve, proceed as follows:

1. Start bender.
2. Drop hydraulic pressure to zero on the sequence or swager valve.

WARNING!

LOCK OUT, TAG OUT, electrical plug. (Secure the plug, so it cannot be plugged into the receptacle; or place a warning tag on it to prevent it from being plugged into the receptacle.)

3. Turn off and LOCK OUT, TAG OUT, all power to the bender.
4. Manually cycle all valves several times to relieve pressure which may be present in the hydraulic lines.
5. Tag and disconnect the hydraulic lines and any wiring to the valves that are to be replaced.
6. Remove the attaching hardware that holds the valve in place. Be sure to note the size and quantity of hardware in each location.
7. Remove the valve.

CAUTION!

Over tightening of valve attaching hardware may distort or damage the valve body.

8. Install the replacement valve and secure using the original attaching hardware.
9. Connect hydraulic hoses or lines to the valve body. Be careful not to over tighten the fittings on the hose ends. They are usually made of a soft material and can easily damage.
10. Connect any wiring (Directional control valve only) that may have been disconnected.
11. Turn the bender on and test the new valve for proper operation. Cycle the valve several times to remove any air which may be trapped inside the valve.
12. Set the PSI on the valve. See Section 11.

BACK PRESSURE CYLINDER REMOVAL

To remove the back pressure cylinder, proceed as follows:

1. Turn the bender on and drop the hydraulic pressure to zero PSI using the sequence valve.
2. Turn the bender off.
3. LOCK OUT, TAG OUT, the bender.
4. Remove the cotter pins or clips retaining the front clevis pin.
5. Remove the clevis pin freeing the chain anchor.

NOTE: Do not move the cylinder rod after the hydraulic hoses are removed. This will draw air into the cylinder and cause erratic bender performance. If air is drawn into the cylinder, the cylinder must be fully stroked to the end in both directions several times to force the air out of the cylinder.

6. Unscrew the hoses from the fittings on the cylinder, and cap or plug the hoses.
7. Remove the cotter pins or clips retaining the clevis pin at the cylinder rear.
8. Remove the clevis pin.
9. Remove the cylinder.

BACK PRESSURE CYLINDER INSTALLATION

To install the back pressure cylinder, proceed as follows:

1. Place the rear end of the cylinder on the bender and secure with a clevis pin.
2. Install pins or clips which retain the clevis pin.
3. Swing the cylinder into position under the bender.

NOTE: When installing the cylinder on the bender, you may need to push or pull the rod end to align the holes on the clevis end. If this is done, you will need to fully stroke the cylinder in both directions to force out any air in the cylinder.

4. Align rod end clevis with chain anchor and install clevis pin.
5. Install the clevis pin retainer.
6. Install hydraulic hoses. Be careful not to over tighten fittings as they are made of soft material and can be damaged easily.
7. Cycle the cylinder several times and perform a bend to ensure proper operation.

HYDRAULIC FLOW SYSTEM

There is no pressure in the hydraulic system when work is not being done on the bender. All valves are open center and the hydraulic fluid flows through the system until the valves are engaged. On this page you will find the hydraulic flow diagram. Use this diagram as a diagnostic tool to aid in troubleshooting any bender hydraulic trouble.

HYDRAULIC FLOW DIAGRAM
FIGURE 13-1

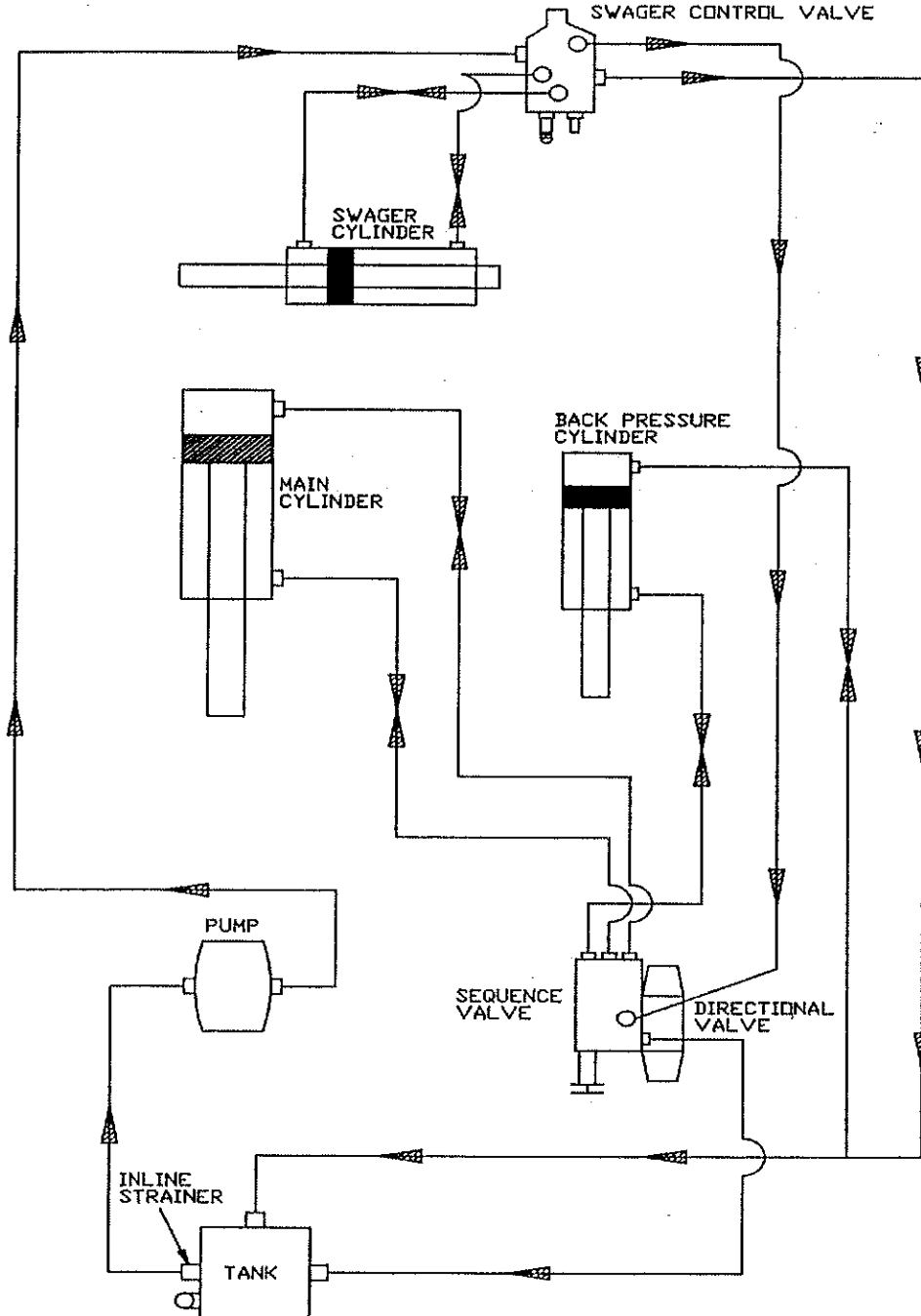

ELECTRICAL REPAIR

INTRODUCTION

The following electrical repair section contains schematics and illustrations to aid in electrical repair. Most of the electrical components cannot be repaired and require only removal and replacement. If replacement parts are installed, refer to Figures 13-2 thru 13-6 for the correct connections. All repairs must be done by a certified electrician. Be sure all safety rules have been read and understood before beginning service.

NOTE: For foreign voltages, be sure voltage, phase, and cycle are identical within the electrical power source.

CAUTION!

Control box contains high voltage.

CAUTION!

Do not use an extension cord between bender and receptacle.

DANGER!

Disconnect power at the receptacle before performing any electrical repairs. High voltage may still be present in the control box after the power is disconnected.

WARNING!

LOCK OUT, TAG OUT electrical plug. (Secure the plug so that it cannot be plugged into the receptacle or place a warning tag on it to prevent it from being plugged into the receptacle.)

PLUG & RECEPTACLE

For the plug and receptacle wiring hook up, see Figure 13-2.

FIGURE 13-2

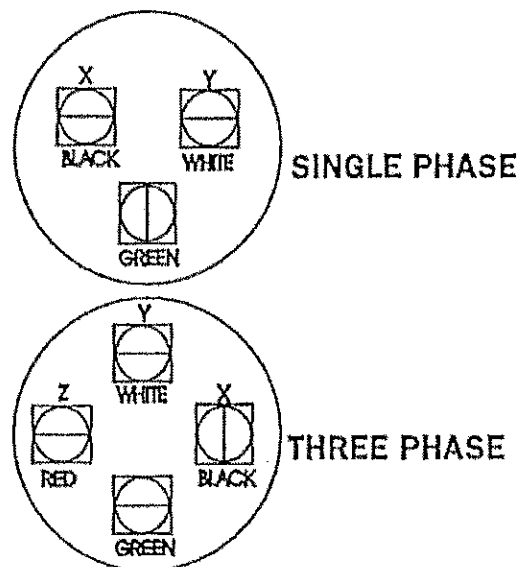

LIMIT SWITCHES

FIGURE 13-3

Depth-of-Bend
Limit Switch

2 - Black
1 - White

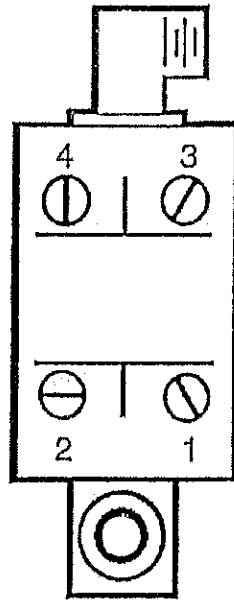
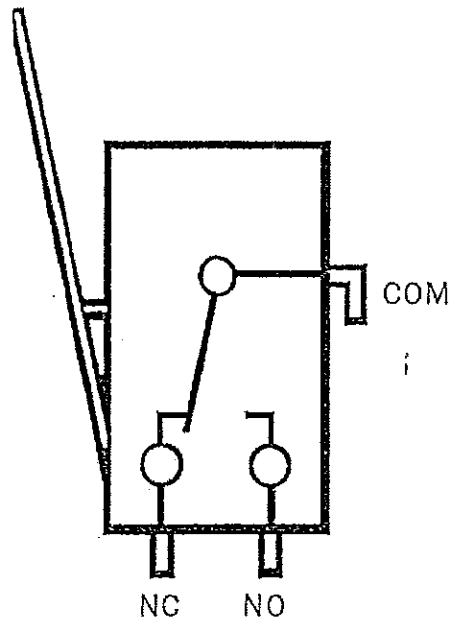

FIGURE 13-4

Home Position
Limit Switch

NO - Black
COM - White



DIRECTIONAL VALVE

For the directional control valve wiring, see Figure 13-5.

FIGURE 13-5

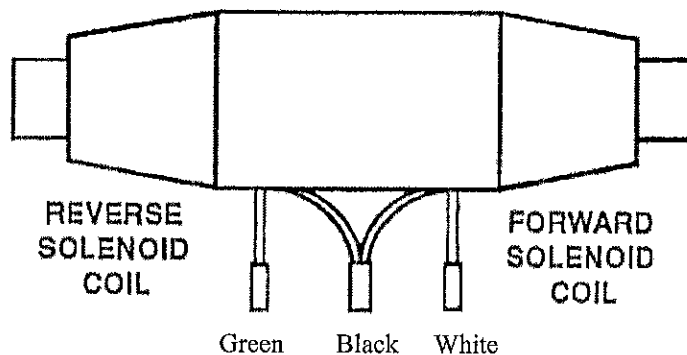

MOTOR

For motor lead connections, refer to the chart below.

Single Phase – 230 Volts

- 1 + 5 Black Motor Lead
- 4 Black Motor Lead
- J + 8 Bundle and Cap

Three Phase – 230 Volts

- 4 + 5 + 6 Together
- 7 + 1 Black Motor Lead
- 8 + 2 Black Motor Lead
- 9 + 3 Black Motor Lead

Three Phase – High Voltage

- 6 + 9 Together
- 5 + 8 Together
- 4 + 7 Together
- 3 Black Motor Lead
- 2 Black Motor Lead
- 1 Black Motor Lead

PUMP/MOTOR ROTATION

When starting a three phase motor, check the motor rotation. The motor should rotate counterclockwise as seen when facing the pump. To check the pump/motor rotation, proceed as follows: (See Figure 13-6)

FIGURE 13-6

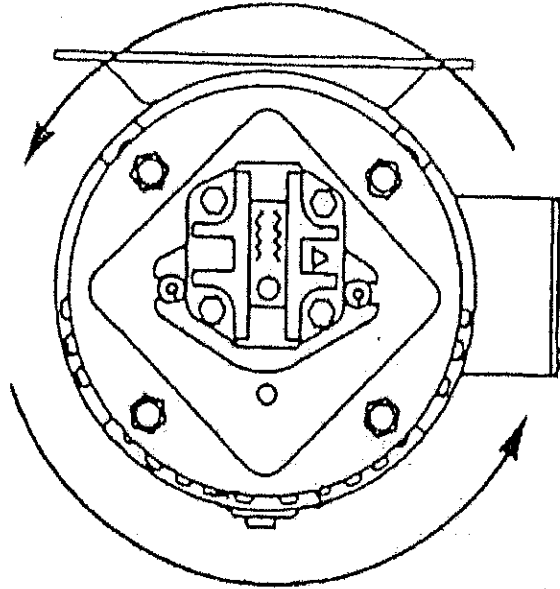

1. Plug in the bender.
2. Turn the bender on.
3. Depress the swager control handle. If the swager cylinder rod extends into the swager box, the rotation is correct. If the cylinder rod does not extend, the rotation is not correct.
4. If rotation is in the wrong direction, turn the bender off and unplug it.
5. Disassemble the plug. Reverse the red and black wires. See Figure 13-2
6. Reassemble the plug and test again.

ELECTRICAL SCHEMATICS

The following schematics may be used as a diagnostic tool in troubleshooting electrical problems.

ELECTRICAL WIRING - 230 VOLTS

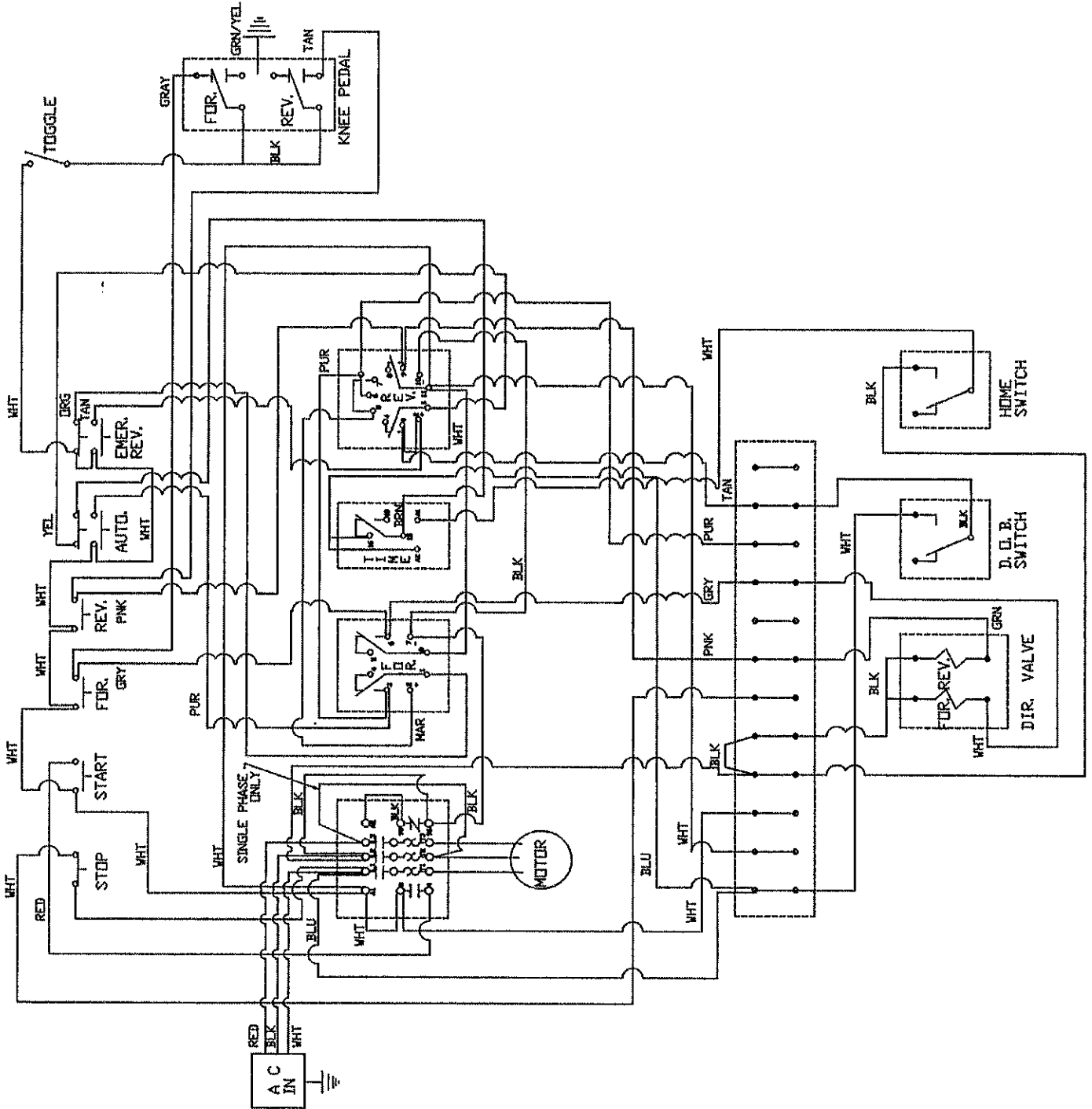

ELECTRICAL WIRING – HIGH VOLTAGE

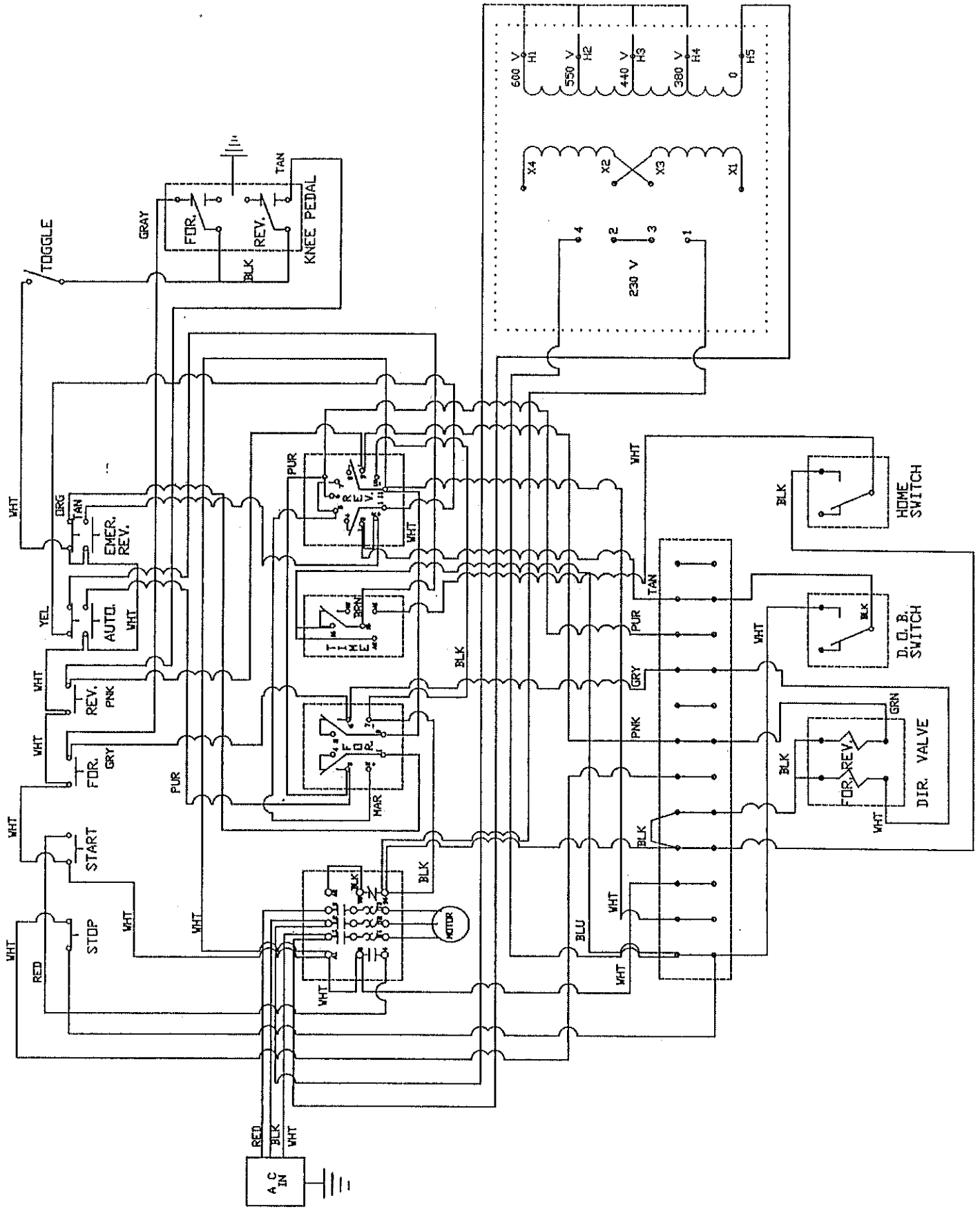

Electrical Components

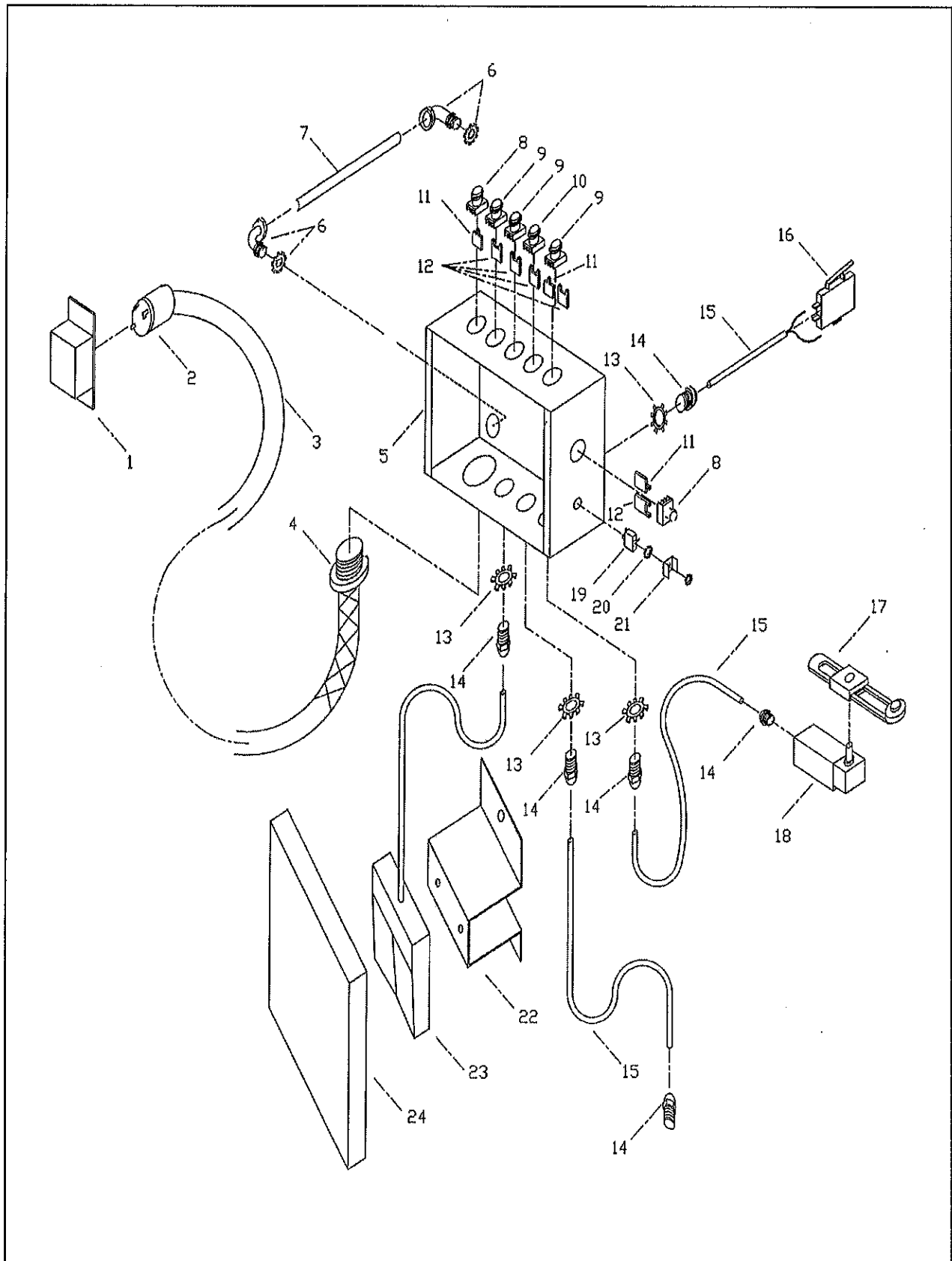

Electrical Components

Key	Part Number	Description	Qty.	Remarks
1	95207	Receptacle	1	Single Phase
	95209	Receptacle	1	Three Phase
2	95206	Plug	1	Single Phase
	95208	Plug	1	Three Phase
3	95370	Cord	1	Single Phase (Sold by the Foot)
	95371	Cord	1	Three Phase (Sold by the Foot)
4	95172	Kellem	1	
5	95539	Control Box Body	1	
	95540	Control Box Lid	1	
6	95236	3/8 - 90 Degree Connector Conduit	2	
7	95234	3/8 Conduit	1	Sold by the Inch
8	95511	Red Push Buuton	2	
9	95512	Green Push Button	3	
10	95513	Black Push Button	1	
11	95514	Closed Contact	3	
12	95515	Open Contact	5	
13	95429	Lock Nut - Cord Grip	4	
14	95449	Cord Grip	6	
15	95508	16-3 Cord	1	Sold by the Inch
16	95420	Home Switch	1	
17	95523	Roller Arm	1	
18	95522	Limit Switch	1	
19	95087	Toggle Switch	1	
20	97254	Star Washer	1	
21	95091	Switch Cover	1	
22	97481	Knee Pedal Mount	1	
23	95419DT	Pedal Switch	1	
24	97448	Knee Pedal Pad	1	

Electrical Control Box Components

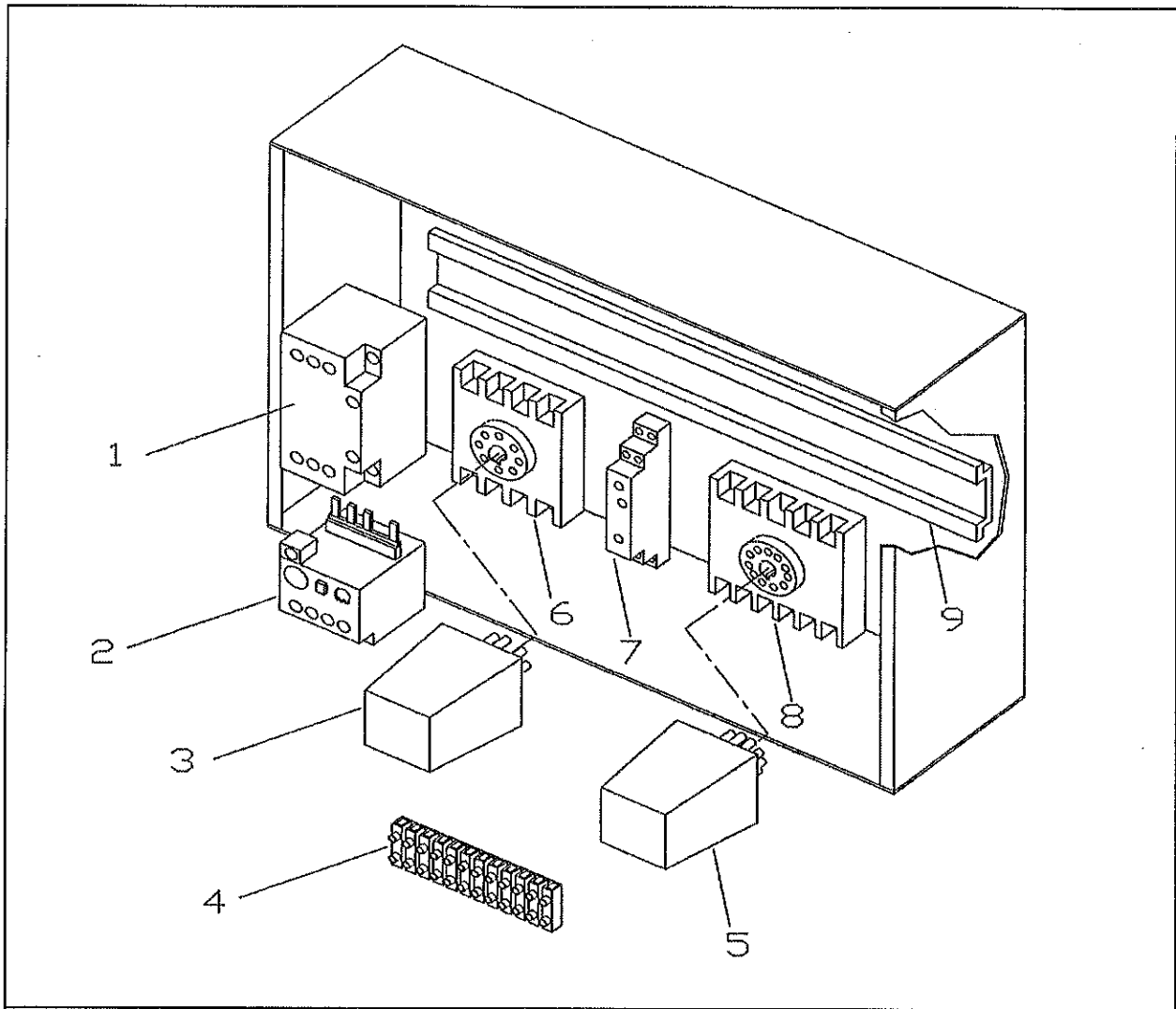

Key	Part Number	Description	Qty.	Remarks
1	95502	Contactors	1	Single Phase
	95519	Contactors	1	Three Phase
2	95503	Overload Relay	1	Single Phase
	95518	Overload Relay	1	Three Phase
3	95460	Relay, DPDT, Eight Pin	1	
4	95507	Terminal Strip	1	
5	95435	Relay, 3D3T, Eleven Pin	1	
6	95462	Eight Pin Relay Socket	1	
7	95461	Timer Relay	1	
8	95463	Eleven Pin Relay Socket	1	
9	95510	Din Rail	1	
	95539	Control Box Body	1	
	95540	Control Box Lid	1	