



HUTH[®]
Ben Pearson
INTERNATIONAL LLC

TUBE EXPANDER MANUAL

BENCHTOP



MODEL 1690

PORTABLE



MODEL 1691

CE

To The Owner

Please take a few minutes to carefully read this manual. It has been designed to help you in realizing the many benefits you anticipated when you purchased your Huth Tube Expander. Every Huth Tube Expander is constructed from the finest materials by highly trained and experienced craftsmen. They have a profound interest in your expander's successful performance and have prepared this manual to give you the benefit of their experience, gained through years of building top-quality expanders and related projects.

The manner in which you operate and the care you provide this expander will have a direct impact on its continued successful performance. Read this entire manual; keep it handy for future reference.

It has always been Huth's policy to improve its products whenever possible and practical to do so. We reserve the right to make changes and/or improvements without incurring any obligation to do so on previously sold products.

Model

Number: _____

Serial

Number: _____

Date

Delivered: _____

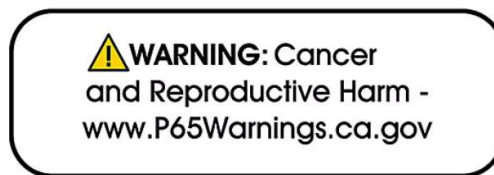

COPYRIGHT 2024 – HUTH BEN PEARSON INTERNATIONAL, LLC

Table of Contents

1.0 Safety Precautions..... 3

- Safety Overview
- General Safety Precautions
- Electrical Safety Precautions
- Hydraulic Safety Precautions

2.0 Compliance.....7

3.0 Upon Delivery.....7

4.0 Setting Up Your Expander.....8

- Expander Operation
- Installing the Accu-Sizer

5.0 Expanding Tooling and Segment Sets.....10

- Flaring Segment Sets
- Male Ball Joint Segment Sets
- Female Ball Joint Segment Sets
- Flange Segment Sets
- Bead Segment Sets
- V-Band Segment Sets
- Expanding Sleeve Segment Sets
- Rod Bracket Bender

6.0 Expanding Tool Chart.....19

7.0 Maintenance.....20

- Before Every Use
- Use After Another Individual or Long Production Runs
- After Adjustments
- Daily
- Weekly
- Monthly

8.0 Troubleshooting.....24

9.0 Electrical Schematics.....27

10.0 Hydraulic Schematics.....28

11.0 Parts and Exploded Views.....29

12.0 Service.....31

13.0 Warranty.....31

1.0 Safety Precautions

Safety Overview

Read all instructions carefully. Follow all recommended safety precautions to avoid personal injury as well as damage to the product and / or damage to other property. Huth Ben Pearson cannot be responsible for any damage or injury from unsafe use, lack of maintenance, incorrect operation, or if any alterations are performed to the equipment that was not provided by Huth Ben Pearson. Do not remove warning labels, tags, or decals. In the event that any questions or concerns arise, contact Huth Ben Pearson.

Save these instructions for future use.

This manual follows a system of safety alert symbols, signals, words, and safety messages to warn the user of specific hazards. Failure to comply with these warnings could result in death or serious personal injury, as well as damage to the equipment or other property. These safety alert symbols appear throughout this manual. The signal words used in this manual are WARNING, CAUTION and NOTICE.

WARNING

 WARNING indicates a hazardous situation which, if not avoided, could result in death or serious injury.

CAUTION

 CAUTION indicates a hazardous situation which, if not avoided, could result in minor or moderate injury.

NOTICE

NOTICE is used to address practices not related to physical injury.

General Safety Precautions

 **WARNING:** Failure to observe and comply with the following precautions could result in death or serious injury.

- Wear eye protection at all times.
- Stand to the side of the machine when operating.
- Do not operate machine while wearing loose/frayed gloves or clothing. Keep hair, fingers, and all other body parts away from the machine's moving parts, as they can become caught in moving parts.
- Handle cut pipes with care, as a cut pipe may be sharp. Good practice is to file the inside of the edges after the pipe is cut.
- Allow only one person at a time to operate the machine.
- Read and understand all decals on the machine and replace any damaged or unreadable decals.

Electrical Safety Precautions

Avoiding Electrical Shock

 **WARNING:** Risk of electric shock! Failure to observe and comply with the following precautions could result in death or serious injury.

- Only connect the machine's power cord to a grounded electrical outlet. Use only a power cord with a ground pin.
- Unplug the machine's power cord from the outlet before performing cleaning, maintenance, or repairs.

Avoiding Explosion

 **WARNING:** Risk of explosion! Failure to observe and comply with the following precautions could result in death or serious injury.

- This machine has internal arcing or sparking parts which should not be exposed to flammable vapors. This machine should not be located in a recessed area or below floor level.

General Electrical Safety

 **WARNING:** Failure to observe and comply with the following precautions could result in death or serious injury. Property damage could also be a result.

- Take precautions so that the machine is not switched on accidentally.
- Always disconnect the machine from AC power supply before transporting it.
- Keep the machine out of reach of children.
- Do not allow inexperienced users or users who have not read the instructions to operate the machine.

Use and Care Electrical Safety

 **WARNING:** Failure to observe and comply with the following precautions could result in death or serious injury. Property damage could also be a result.

- Always be certain that the machine is off and disconnected from AC power supply before performing any inspection, maintenance, or repair procedures.
- Do not use the machine if it cannot be switched on and off using the rotary switch. The electrical issue or machine must be repaired before use.
- Make sure the motor fan vents are not obstructed and free of dirt and dust.
- Do not service or clean the machine while the machine is operating and/or if the machine is connected to AC power supply.

- Do not operate the machine with a damaged power cord or plug. Call Huth Ben Pearson customer service center for repair parts or mechanical adjustments (see the service section, page 29).
- Do not operate if the machine malfunctions, is dropped, or damaged in any manner. Call Huth Ben Pearson customer service center for repair parts or mechanical adjustments (see the service section, page 29).

Hydraulic Safety Precautions

General Hydraulic Safety

 **WARNING:** Failure to observe and comply with the following precautions could result in death or serious injury. Property damage could also be a result.

- Before operating the machine, all hose connections must be tightened with the proper tools. Connections should be tightened securely and leak-free. Do not overtighten, overtightening can cause thread failure or cause high pressure fittings to split even when pressures are lower than their rated capacities.
- The system operating pressure must not exceed the pressure rating of the lowest rated component in the system. Ensure to use the pressure gauge that is installed in the system to monitor operating pressure. It is your window to see what is happening in the system.
- Should a hydraulic hose ever rupture, burst, or need to be disconnected, immediately depress the foot pedal, to the right, to release all pressure and shut off the machine. Never attempt to grasp a leaking pressurized hose with your hands. The force of escaping hydraulic fluid could inject under the skin causing serious injury, seek medical attention immediately.
- Hose material must be compatible with the hydraulic fluid used. Hoses must not come in contact with corrosive materials such as creosote-impregnated objects and some paints. Consult the manufacturer before painting a hose. Hose deterioration due to corrosive materials can result in personal injury.

Hydraulic Pump Safety

 **WARNING:** Failure to observe and comply with the following precautions could result in death or serious injury. Property damage could also be a result.

- Do not exceed the 3,200 PSI hydraulic pressure rating.
- Do not adjust the internal high pressure relief valve.

 **CAUTION:** Failure to observe and comply with the following precautions could result in minor or moderate injury. Property damage could also be a result.

- Do not use or repair damaged hydraulic hoses. Avoid sharp bends and kinks. Using a bent or kinked hose will cause severe back-pressure. Sharp bends and kinks will internally damage the hose, leading to premature hose failure.
- Do not drop heavy objects on a hydraulic hose. A sharp impact may cause internal damage to the hose. Applying pressure to a damaged hose may cause it to rupture.
- Keep hydraulic equipment away from flames and heat. Excessive heat will soften packings and seals resulting in fluid leaks. Heat also weakens hose materials and packings.

Hydraulic Cylinder Safety

 **WARNING:** Failure to observe and comply with the following precautions could result in death or serious injury. Property damage could also be a result.

- Do not exceed the rated capacity of the cylinder. Excess pressure can result in personal injury.
- Do not set poorly balanced or off-center loads on the cylinder shaft/arbor. The load can tip and cause personal injury.
- Stay clear of cylinders and tools while being pressurized or in operation. To avoid personal injury, keep hands and feet away from pinch point areas.

2.0 Compliance

Huth Ben Pearson declares that the Tube Expander Models 1690 and 1691 have been tested and conform to applicable standards and are approved to carry the CE certification mark.



3.0 Upon Delivery

- Inspect for shipping damage or shortages. Contact the shipping carrier for any complaints or concerns with damage to product or missing piece counts.
- Remove the hydraulic tank's plug and replace with the breather.
- Install the provided power cord plug in the supplied receptacle (contact a local electrician to properly install the supplied receptacle).
 - 110V Model: Requires 30 amp service
 - 220V Model: Requires 20 amp service

 **WARNING:** Risk of electric shock! Failure to observe the following instructions and precautions, from the electrical safety precautions section, may result in serious personal injury or death.

- Use the rotary switch to turn the unit On, while standing to the side of the arbor.

 **CAUTION:** Never stand directly in front of the arbor when operating. Failure to observe and comply with the following precautions could result in minor or moderate injury. Property damage could also be a result.

- Depress the foot pedal to the right in order to extend the cylinder shaft. Then depress the foot pedal to the left in order to retract the cylinder shaft. When the cylinder is completely retracted, the pressure will build to 3,200PSI (the expander will properly operate within the range of 3,000-3,200 PSI).

 **WARNING:** DO NOT EXCEED 3,200 PSI. Failure to observe and comply with the following precautions could result in death or serious injury. Property damage could also be a result.

- Use the rotary switch to turn the machine off.

4.0 Setting Up Your Expander

Expander Operation

The Huth Benchtop Expander comes equipped with the Accu-Sizer Expanding Kit. The Accu-Sizer needs to be installed into position on the expanding cylinder.

Installing the Accu-Sizer

1. Install the adjustable collar (41047) assembly over the cylinder shaft and cylinder tie rods.
2. Secure the assembly to the cylinder using the two, ½"-13, jam nuts provided. Locate these in opposite corners. **NOTICE:** Do not over tighten, only finger tighten so the collar can self-center.
3. Install the arbor on to the cylinder shaft, as shown below (Figure 1), a wrench may be used to secure the arbor. **NOTICE:** Be sure that the arbor is all the way onto the shaft. **NOTICE:** Loose parts may cause equipment and/or property damage. **NOTICE:** Do not over tighten.



Figure 1. Arbor on the cylinder shaft

4. Lightly grease the arbor and face of the adjustable collar (the adjustable collar has already been calibrated at factory).
5. Completely extend the cylinder by depressing the foot pedal to the right. **NOTICE:** Always completely extend the cylinder before installing any segment set.
6. Select the desired expanding segment set according to the color coded expanding chart, as shown below (Figure 2). **NOTICE:** The most commonly used sizes are identified on the expanding chart. If a dimension is desired that is not noted, always begin with the adjustable collar inward and gradually move it outward to make the expansion.

Setting	Size	Segment	Arbor
①	4" ID	478	
②	3-1/2" ID	477	
③	3" ID		
	76mm ID	476	
④	76mm ID		
	2-3/4" ID		
⑤	63mm ID		
	2-1/2" ID		
⑥	50mm ID	475	
⑦	50mm ID		
	2-1/8" ID		573
⑧	2-1/8" ID		
	54mm ID		
	2-1/4" ID		
⑨	2" ID		
⑩	50mm ID	474	
⑪	48mm ID		
⑫	1-7/8" ID		
⑬	2" OD		
⑭	45mm ID		
⑮	1-3/4" ID		
⑯	42mm ID		
⑰	1-3/4" ID	473	572
⑱	40mm ID		
⑲	1-1/2" ID		
⑳	38mm ID		

Figure 2. Accu-sizer expanding chart

7. Select the correct arbor according to the chart. The small arbor is used only with the red segment set for 1½” – 1¾” expansions. The large arbor is used for the remaining segment sets. ***NOTICE:*** Always use the correct segment with the correct arbor. Failure to do so could result in tool breakage. ***NOTICE:*** When performing a non-calibrated expansion always begin with the adjustable collar inward and gradually move it outward to make the expansion. If the collar is left fully extended, prolonged use may distort the end threads and lock up the collar.
8. Install the segment set on the arbor by pressing the center opening of the segment over the arbor, as shown below (*Figure 3*).



Figure 3. Segment set on the arbor

9. Select the desired expanding size by rotating the adjustable collar and aligning the proper color coded number in the indicator hole.
10. Place the material to be expanded over the segment set until it reaches the segment base.
11. Depress the foot pedal to the left to retract the arbor and begin expanding. Continue to expand until the cylinder is completely retracted.
12. Depress the foot pedal to the right to release the segment set from the material.
13. Slightly rotate the material and repeat operations 9-11, to give a round expansion, as shown below (*Figure 4*).



Figure 4. Expansion completely round

5.0 Expanding Tooling and Segment Sets

Flaring Segment Sets (#440)

Flares from 1½” - 2½”

NOTICE: Smaller diameters should be gradually worked up onto the segment set.

1. Install the 573 arbor, ensure it is securely tightened onto the cylinder shaft.
2. Slide the flaring segment set over the arbor, as shown below (*Figure 5*).



Figure 5. Flaring segment set on the arbor

3. Place the tubing over the arbor and segment set, as shown below (*Figure 6*). ***NOTICE:*** Do not place the end of the tubing past the last step (tooth) on the segment.



Figure 6. Tubing placement over arbor and segment set

4. Depress the foot pedal to the left and rotate the tubing to produce the desired flare.

Male Ball Joint Segment Sets

Produces male ball joints on tubing from 1 $\frac{3}{4}$ " – 3"

1. Install the 573 arbor, ensure it is securely tightened onto the cylinder shaft.
2. Slide the ball joint segment over the arbor, as shown below (*Figure 7*).



Figure 7. Ball joint segment set on the arbor

3. Place the tubing over the arbor and the segment set until the end of the tubing touches the base of the segment set.
4. Depress the foot pedal to the left to form the male ball joint, as shown below (*Figure 8*), ensure not to distort/over expand the open end of the tubing.



Figure 8. Male ball joint formed

Female Ball Joint Segment Sets

Produces female ball joints on tubing from 1 $\frac{3}{4}$ " – 3"

1. Install the 573 arbor, ensure it is securely tightened onto the cylinder shaft.
2. Slide the ball joint segment over the arbor.
3. Place the tubing over the arbor and segment set until the end of the tubing is at the groove of the ball.
4. Depress the foot pedal to the left to form a female ball joint at the end of the tubing in order to fit the male ball joint, as shown below (*Figure 9*).



Figure 9. Female ball joint formed

Flange Segment Sets

Flange sets are for tubing 2" – 2½" and come with ring sizes of 2", 2¼", and 2½"

1. Place the segment set over the arbor, ensure it is secured into position, as shown below (*Figure 10*).



Figure 10. Flange segment set on the arbor

2. Place the flange ring over the end of the tubing.
3. Place the tubing over the arbor and segment set until it meets the base of the segment set.
4. Push the flange ring forward until it touches the base of the segment set.
5. Press the foot pedal to the left to form the flange. The flange will be formed when the tubing meets the inside of the flange ring, as shown below (*Figure 11*).



Figure 11. Tubing meets the inside of the flange ring, flange formed

Bead Segment Sets

Forms beads at the end of the tube to slip a hose over the end and secure it in place with a clamp

1. Install the proper arbor and bead segment securely to the cylinder shaft, as shown below (*Figure 12*).



Figure 12. Bead segment set on the arbor

2. Completely retract the adjustable collar.
3. Depress the foot pedal to the left to completely retract the cylinder shaft.
4. Place the tube over the end of the segment set, as shown below (*Figure 13*).
NOTICE: Do not place the tube over the bead.



Figure 13. Tube over the bead segment set

5. Screw the adjustable collar outward until it stops.
6. Remove the tube and extend the arbor with the segment outward.
7. Place the tube completely over the segment set until the tube reaches the base.
8. Depress the foot pedal to the left to completely retract the arbor, the segment set will form the bead without changing the tubes original diameter, as shown below (*Figure 14*).



Figure 14. Bead is formed

V-Band Segment Sets

Forms the male end of a V-Band joint

1. Install the proper arbor and V-Band segment set securely to the cylinder shaft, as shown below (*Figure 15*).



Figure 15. V-Band segment set on the arbor

2. Completely retract the adjustable collar.
3. Depress the foot pedal to the left to completely retract the cylinder shaft.
4. Place the tube over straight/short end of the segment, as shown below (*Figure 16*)



Figure 16. Tube over segment set

5. Screw the adjustable collar outward until it stops.
6. Remove the tube and extend the arbor with the segment outward.
7. Place the tube completely over the segment set until it reaches the base.
8. Depress the foot pedal to the left to completely retract the arbor, the segment set will form the male V-Band without changing the tubes original diameter, as shown below (*Figure 17*).



Figure 17. Male V-Band formed

Expanding Sleeve Segment Sets

Forms a larger expansion on tubes by slipping the sleeve segment set over a 3” segment set turning it into a 5” expansion sleeve set

NOTICE: Not intended for high volume expansions, sleeves are not heat treated.

1. Install the 3” segment set and arbor securely to the cylinder shaft.
2. Place the desired expanding sleeve (3.5”, 4”, 5”) completely over the working surface of the 3” segment set, as shown below (*Figure 18*).



Figure 18. 3" Expansion sleeve on the arbor

3. Set the adjustable collar for a 3” I.D. expansion.
4. Place the tube over the expanding sleeve end. ***NOTICE:*** Do not go beyond the sleeve end.
5. Depress the foot pedal to the left to completely retract the arbor, the segment and sleeve will form the I.D. size of the expanding sleeve selected, as shown below (*Figure 19*).



Figure 19. 3" Expansion formed

Rod Bracket Bender

Forms bends on material sizes up to ½” round or ¼” x 1” flat, low carbon steel

1. Screw the adjustable collar all the way in.
2. Depress the foot pedal to the right to fully extend the cylinder.
3. Screw the rod bender arbor on to the cylinder shaft all the way with the pin upward, as shown below (*Figure 20*).



Figure 20. Rod bender arbor on the cylinder shaft

4. Slide bending block on the arbor until arbor pin bottoms out in the block slot, as shown below (*Figure 21*).



Figure 21. Bending block on the arbor

5. Depress the foot pedal to the left to retract the cylinder.
6. Screw adjustment collar out to meet the block. This will allow for the maximum bend angle.

⚠ WARNING: Keep hands and limbs away from the pinch point between the material and the side of the rod bender bracket. Failure to observe and comply with the following precautions could result in death or serious injury.

7. Place the material between the arbor pin and the block pins.
8. Depress the foot pedal to the left to retract the arbor until the material is bent to the desired degree, as shown below (*Figure 22*).



Figure 22. Material bent

9. Adjust the collar to the block, as necessary, as adjustments to the collar control the amount of bend achievement.
10. Release the cylinder by depressing the foot pedal to the right. If more bends of the same angle are to be produced, set the adjustment collar to limit the travel of the arbor and the depth of the bend.

6.0 Expanding Tool Chart

All Huth Ben Pearson tooling is machined, not cast, gas-carburized, oil-quenched, heat-treated. Minimum hardness of 58 Rockwell "C". Expanding tooling is available for 1" to 6". All Huth Ben Pearson tooling is available from shelf stock. Huth Ben Pearson will manufacture to your tooling specification sizes that are not listed in the Tooling Charts.

ALL SIZES ARE INTERNAL DIAMETER

Accu-Size Slip Expansions			
Size (ID)	Arbor	Segment	Collar
1 3/8" – 1 3/4"	572	472	41047
1 3/4" – 2 1/8"	573	474	41047
2 1/8" – 2 1/2"	573	475	41047
2 1/2" – 3"	573	476	41047
3" – 3 1/2"	573	477	41047
3 1/2" – 4"	573	478	41047

Other Slip Expansions			
Size (ID)	Arbor	Segment	Collar
1 15/16" – 1 3/32"	575*	470	41047
Use with 570 Spacer			
1 3/32" – 1 1/4"	575*	404	41047
Use with 570 Spacer			
1 1/4" – 1 1/2"	500	400	41047
2 3/4" – 3 1/8"	503	403	523
3 1/8" – 3 1/2"	503	406	523
3 1/2" – 4"	503	408	523
4" – 4 7/8"	503	450	523
4 7/8" – 5 1/2"	503	451	523

45° Flaring			
Size (ID)	Arbor	Segment	Collar
1" – 1 1/2"	575*	405	41047
Use with 570 Spacer			
1 1/2" – 2 1/2"	573	440	41047
2 1/2" – 3 1/2"	573	441	41047

Ball Joints			
Size (ID)	Arbor	Segment	Collar
1 3/4"	573	410	41047
2"	573	419	41047
2 1/4"	573	420	41047
2 1/2"	573	421	41047
2 3/4"	573	454	41047
3"	573	452	41047
3 1/2"	503	453	523

Beads			
Size (ID)	Arbor	Segment	Collar
1 1/4"	575*	460	41047
Use with 570 Spacer			
1 1/2"	500	461	41047
1 3/4"	572	462	41047
2"	573	463	41047
2 1/4"	573	464	41047
2 1/2"	573	465	41047
3"	573	466	41047
3 1/2"	573	467	41047
4"	573	468	41047

V-Bands			
Size (ID)	Arbor	Segment	Collar
2"	573	435	41047
2 1/4"	573	436	41047
2 1/2"	573	437	41047
2 3/4"	573	438	41047
3"	573	439	41047

Expander Sleeves		
Size (ID)	Sleeve	Segment
3 1/2"	9001-35	476
4"	9001-40	476
4 1/2"	9001-45	476
5"	9001-50	476

7.0 Maintenance

The Benchtop Expanders are designed for trouble free operation with minimum maintenance. If you observe the maintenance requirements given below, it will greatly extend the expander's life without trouble and costly repair.

Before Every Use

- Ensure that the arbor is fully threaded onto the cylinder shaft.
- Lubricate the face of the adjustable collar and the work surface of the arbor.

NOTICE: *A lack of lubrication can lead to earlier wear or damage to the unit.*

- Inspect all tooling for damage or cracks.



CAUTION: Do not use damaged or cracked tooling. Failure to observe and comply with the following precautions could result in minor or moderate injury. Property damage could also be a result.

Use After Another Individual OR Long Production Runs

- Ensure the arbor is fully threaded onto the cylinder shaft.
- Lubricate the face of the adjustable collar and the work surface of the arbor.

NOTICE: *A lack of lubrication can lead to earlier wear or damage to the unit.*

- Inspect all tooling for damage or cracks.



CAUTION: Do not use damaged or cracked tooling. Failure to observe and comply with the following precautions could result in minor or moderate injury. Property damage could also be a result.

After Adjustments

- Ensure the arbor is fully threaded onto the cylinder shaft.
- Inspect all tooling for damage or cracks.



CAUTION: Do not use damaged or cracked tooling, failure to observe and comply with the following precautions could result in minor or moderate injury. Property damage could also be a result.

Daily

- Ensure the arbor is fully threaded onto the cylinder shaft.
- Lubricate the face of the adjustable collar and the work surface of the arbor.

NOTICE: *A lack of lubrication can lead to earlier wear or damage to the unit.*

- Inspect all tooling for damage or cracks.

 **CAUTION:** Do not use damaged or cracked tooling. Failure to observe and comply with the following precautions could result in minor or moderate injury. Property damage could also be a result.

- Check all hoses for punctures, wear spots, or leaks. Immediately address hose(s) with punctures, wear spots, or leaks and replace the hose(s).

 **WARNING:** Should a hydraulic hose ever rupture, burst, or need to be disconnected, immediately depress the foot pedal to the right, to release all pressure, and shut off the machine. Never attempt to grasp a leaking pressurized hose(s) with your hands. The force of escaping hydraulic fluid could inject under the skin causing serious injury, seek medical attention immediately. Failure to observe and comply with the following precautions could result in death or serious injury.

- Check all fittings for any leaks, damage, or cracks. Immediately address any leaking, damaged, or cracked components and replace any broken or worn components.

 **WARNING:** Fittings are made of a soft material, over tightening may damage fittings and cause leaks. If damage is not noticed the force of escaping hydraulic fluid could inject under the skin causing serious injury, seek medical attention immediately. Failure to observe and comply with the following precautions could result in death or serious injury.

Weekly

- Ensure the arbor is fully threaded onto the cylinder shaft.
- Inspect all tooling for damage or cracks.

 **CAUTION:** Do not use damaged or cracked tooling. Failure to observe and comply with the following precautions could result in minor or moderate injury. Property damage could also be a result.

- Clean the unit of excessive grease and debris.

NOTICE: Grease, grit, and dirt should not be allowed to accumulate on the machine, as this could cause wear on moving parts and reduce the effectiveness of the machine.

NOTICE: Only use mild detergents or degreaser to clean the machine's components, as strong cleaning solvents may damage the machine's components.

 **WARNING:** When using cleaning solvents always read, understand, and follow the manufacturer's safety and use instructions. Failure to observe and comply with the following precautions could result in death or serious injury.

NOTICE: Do not use an air hose on the motor or around the oil tank breather cap.

- Check the power cord, foot pedal and directional valve cords for damage or wear spots. If damage or wear spots are found unplug the machine at the power source.

NOTICE: Do not unplug the machine's power cord by yanking or pulling on it.

Monthly

- Check the oil level of the hydraulic oil tank, ensure the cylinder is fully retracted.

NOTICE: *The oil should be 1" to 1 ½" below the top of the fill hole when the cylinder is fully retracted. Use ISO Grade 46 Hydraulic Oil.*

- Perform an oil change every 1,000 hours.

NOTICE: *When changing oil, you will need one gallon of new oil. Use ISO Grade 46 Hydraulic oil.*

- Verify the hydraulic pressure is in the range of 3,000 PSI – 3,200 PSI.



NOTICE: *The pressure can be read on the pressure gauge by fully retracting the cylinder shaft into the cylinder. If the pressure is out of the range mentioned above, contact Huth Ben Pearson.*

 **WARNING: DO NOT EXCEED 3,200 PSI.** If the unit is ran higher than 3,200 PSI damage to the machine's components can occur, such as bursting hoses and/or cracked fittings. If this occurs the force of escaping hydraulic fluid could inject under the skin causing serious injury, seek medical attention immediately. Failure to observe and comply with the following precautions could result in death or serious injury.

8.0 Troubleshooting

The following information is intended to be used only as an aid in determining if a problem exists. For any further repair/service questions or concerns contact Huth Ben Pearson.

Electrical Troubleshooting Table		
 WARNING: Failure to observe and comply with the Electrical Safety Precautions in section one (1.0) could result in death or serious injury.		
Problem	Potential Cause	Action
Motor does not run	A. Circuit breaker is off	Turn breaker on.
	B. Incorrect wiring	Check voltage supply, phase, and wiring.
	C. Low voltage	If an extension cord is being used check that it is a heavier gauge and/or the shortest length of extension cord possible for reach.
	D. Poor connection at outlet/plug	Unplug machine from power source. Check receptacle voltage. Check connections at power plug.
	E. Cut in power cord	Inspect and repair or replace power cord.
	F. Start/stop switch defective	Have a qualified electrician test and replace, if needed.
	G. Motor defective	Have a qualified electrician test and replace, if needed.
	H. Motor starter/contacter defective	Have a qualified electrician test and replace, if needed.
Motor stops under load	A. Low voltage	If an extension cord is being used check that it is a heavier gauge and/or the shortest length of extension cord possible for reach.
Motor shuts off	A. Overload safety turning motor off	If problem persists, have a qualified electrician check wiring for short circuits. Check to determine if the motor is overloaded.
	B. Motor starter/contacter defective	Have a qualified electrician test and replace, if needed.
Motor smokes	Stop machine. Unplug machine from power source.	Have a qualified electrician check voltage supply at receptacle, replace if needed.
Motor runs hot	A. Motor fan vents blocked or damaged	Remove dirt or other debris from fan vents on top of the motor.
Unit emits shocks	A. Lost ground connection	Check plug to receptacle fit. Check plug wiring. Check cord for damage. Check ground connection at control box.

Hydraulic Troubleshooting Table			
<p> WARNING: Failure to observe and comply with the Hydraulic Safety Precautions, in section one (1.0), could result in death or serious injury.</p>			
Problem	Possible Cause	Action	
Loss of pressure/power	A. Low oil level	Add oil per maintenance section 7.	
	B. Pressure gauge defective	Replace pressure gauge.	
	C. Bad cylinder seal(s)	Inspect for leaks. Test cylinder. <ul style="list-style-type: none"> • Fully extend the cylinder. • Remove the hose from the front of the cylinder. • Place the open end of the hose in a bucket. • Extend the cylinder. • Results: <ul style="list-style-type: none"> -Oil spillage from hose, bad seals. -No oil spillage from hose, good seals. 	
	D. External leak	Inspect fittings and hoses for leaks.	
	E. Directional valve not fully engaging	Manually override valve. <ul style="list-style-type: none"> • Push the small button on the end of the valve's coil (retract, left coil/extend, right coil). • Results: <ul style="list-style-type: none"> -Button does not depress, valve is defective. Replace valve. -Manual operation successful, check voltage at the valve's coil. If voltage is present, the coil is defective. Replace valve. 	
			
	F. Material too heavy for machine	Check that pressure meets the correct pressure range (3,000-3,200 PSI).	
	G. Relief valve set too low	Contact Huth Ben Pearson.	
H. Pump defective	Contact Huth Ben Pearson.		
Erratic or "jumpy" hydraulics	A. Air in the hydraulic system	Check all hoses and fittings are tight. Fully cycle the expander several times until system is purged.	
	B. Low oil level	Add oil per maintenance section 7.	
	C. Tube material not fully on segment	Check that the tube is placed fully to the base of the segment set.	

Hydraulic Troubleshooting Table (continued)

 **WARNING:** Failure to observe and comply with the Hydraulic Safety Precautions, in section one (1.0), could result in death or serious injury.

Problem	Possible Cause	Action
Motor runs but no cylinder movement	A. Low oil level	Add oil per maintenance section 7.
	B. Pump defective	Contact Huth Ben Pearson.
	C. Bad cylinder seal(s)	Inspect for leaks. Test cylinder (see process “Loss of pressure/power”, section C).
	D. Directional valve not fully engaging	Manually override valve (see process “Loss of pressure/power”, section E).
	E. Loss of electrical signal	Unplug machine from power source. Check continuity at foot pedal and at directional valve.
Directional valve not functioning correctly	A. Low voltage	Check voltage at valve.
	B. Directional valve not fully engaging	Manually override valve (see process “Loss of pressure/power”, section E).
Cylinder moves slowly	A. Low oil level	Add oil per maintenance section 7.
	B. Directional valve not fully engaging	Manually test valve (see process “Loss of pressure/power”, section E).
	C. Bad cylinder seal(s)	Inspect for leaks. Test cylinder (see process “Loss of pressure/power”, section C).
Cylinder drifts back on its own	A. Low oil level	Add oil per maintenance section 7.
	B. Bad cylinder seal(s)	Inspect for leaks. Test cylinder (see process “Loss of pressure/power”, section C).
Cylinder will not return	A. Return flow is restricted or blocked	Check hose(s) for kinks or nonconformities.
	B. Directional valve malfunction	Manually override valve (see process “Loss or pressure/power”, section E).
Foot pedal malfunction	A. Foot pedal cord has cuts, wear spots, or pulled out of the pedal end or motor end	Replace foot pedal pendant assembly, contact Huth Ben Pearson.

9.0 Electrical Schematics

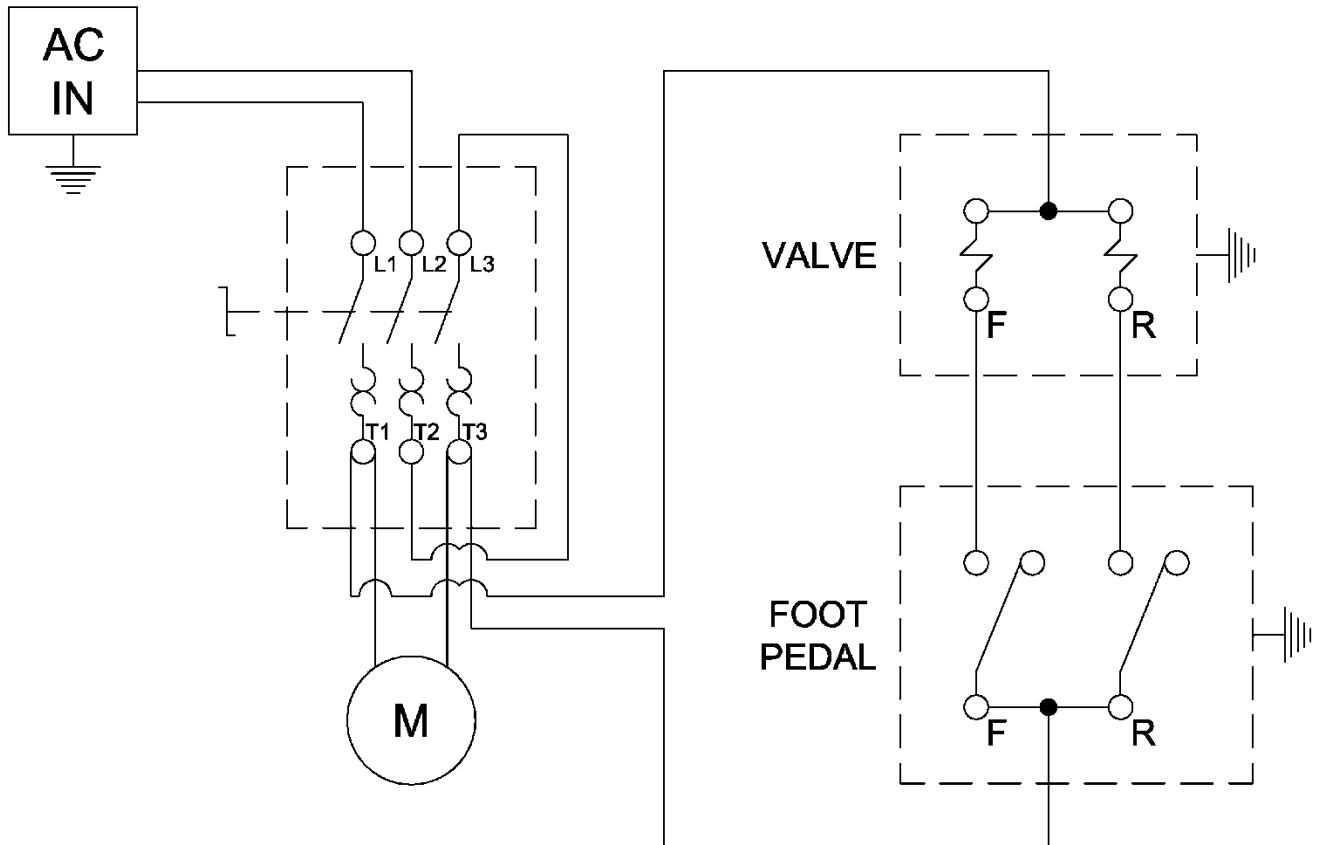

10.0 Hydraulic Schematics

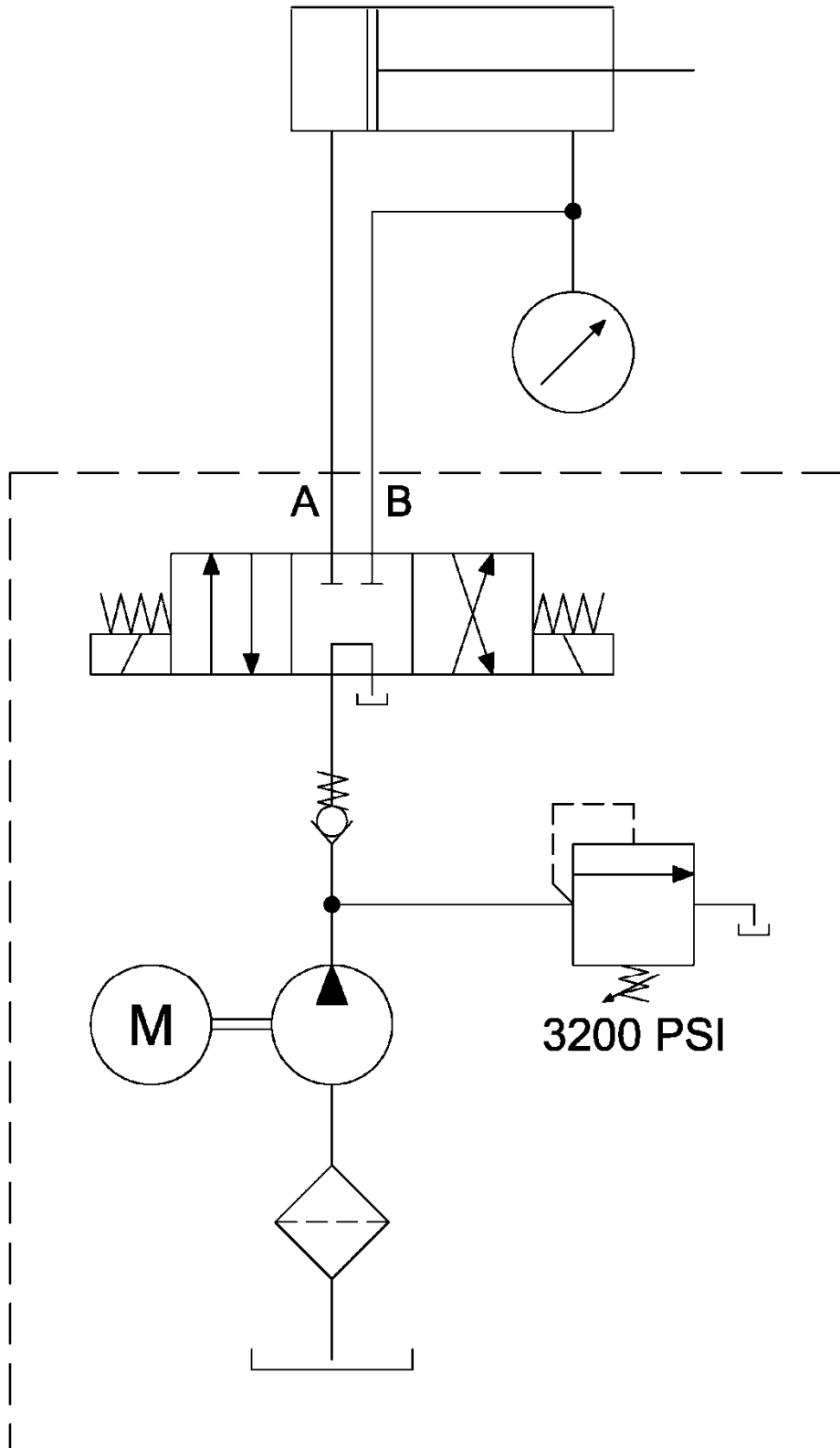

11.0 Parts and Exploded Views

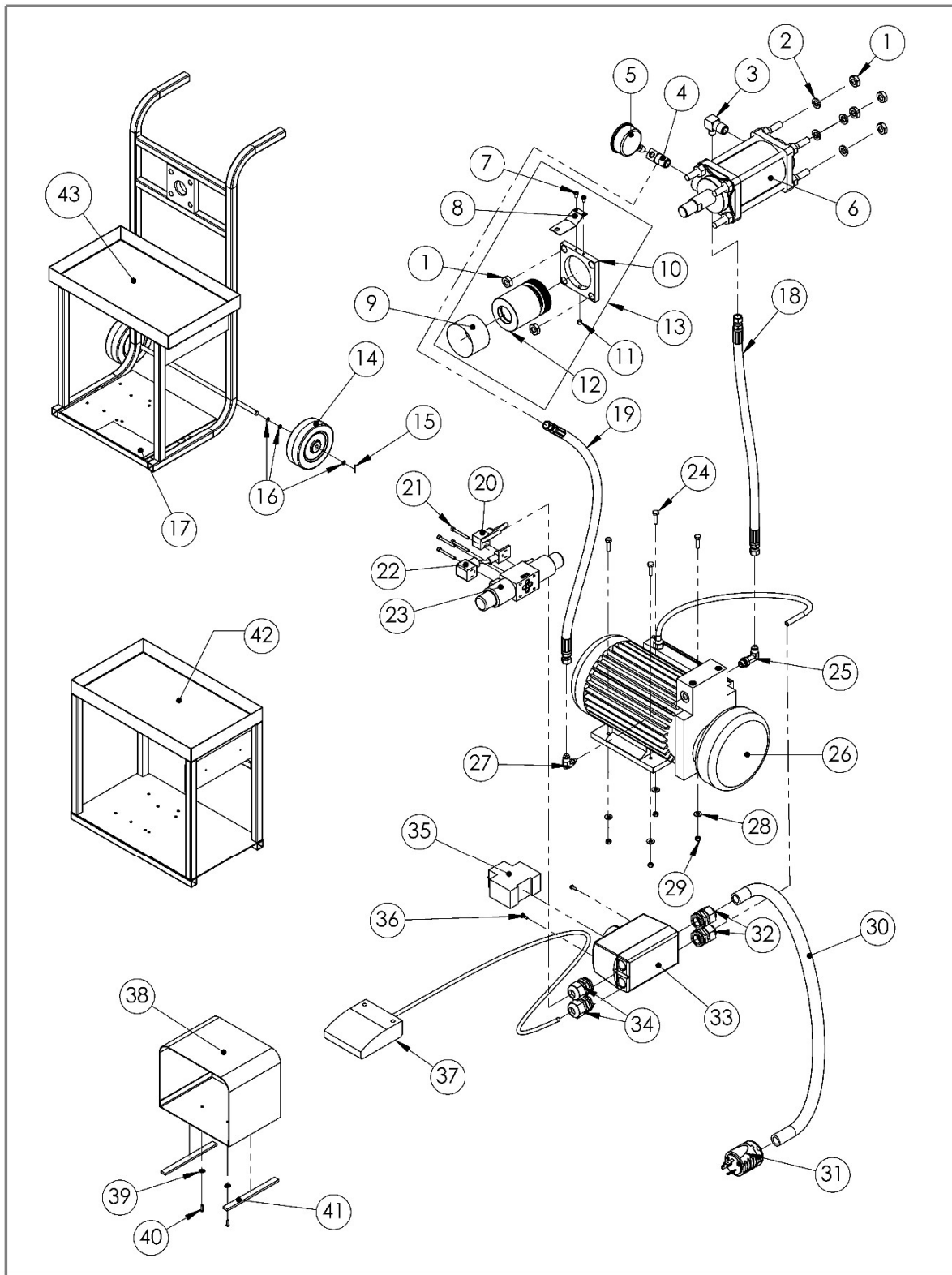

Item No.	Part Number	Description	QTY.
1	H97208	Nut, Jam 1/2-13	6
2	H97383	Washer, Lock, 1/2	4
3	H92009	Fitting, Elbow, 90, #8MNPT - #6MJIC (1691)	1
	H92002	Fitting, Straight, #8MNPT - #6MJIC (1690)	1
4	H92009DT	Fitting, Elbow, 90, #8MNPT - #6MJIC w/ #4FNPT	1
5	H92099	Pressure Gauge, Back Mount (1690)	1
	H92100	Pressure Gauge, Bottom Mount (1691)	1
6	H92375	Cylinder, 3.5" x 3"	1
7	H97240	Machine Screw, 10-32 x 3/8	2
8	H595	Adjustable Collar Gun Sight	1
9	H98126	Decal, Calibration 3-1/2" Cyl	1
10	H520	Plate, Adjustable Collar 357	1
11	H515	Screw, Set, 5/8-16 x 3/8	1
12	H522	Adjustable Collar, Assembly	1
13	H41047	Adjustable Collar	1
14	H97059	Caster, 6 x 2	2
15	BP7100175	Cotter Pin, 1/8 x 3/4	2
16	H97045	Washer, Flat, 1/2"	6
17	H98127	Decal, Sizing Chart, 3-1/2" Cyl	1
18	H92271	Hydraulic Hose, 3/8", 30" Long (1691)	1
	H92265	Hydraulic Hose, 3/8", 16" Long (1690)	1
19	H92270	Hydraulic Hose, 3/8", 24" Long (1691)	1
	H92298	Hydraulic Hose, 3/8", 13" Long (1690)	1
20	H95542A	Din to Loose Wire Harness 72"	1
21	H97517	SHCS, 10-24 x 1-3/4	4
22	H95542B	Dinn to Dinn Interface Cable	1
23	H92164	Directional Valve, D03, 220V	1
	H92171	Directional Valve, D03, 110V	1
24	H97490	Hex Bolt, 1/4-20 x 1	4
25	H92065	Fitting, Elbow, 90, #6MORB, #6MJIC LL	1
26	H1617	Power Unit - 1690 / 1691	1
27	H92071	Fitting, Elbow, 90, #6MORB - #6MJIC (1691)	1
	H92066	Fitting, Elbow, 45, #6MORB - #6MJIC (1690)	1
28	H97395	Washer, Flat 1/4	4
29	H97210	Nut, Lock, 1/4-20	4
30	H95370	10-3 Cord - 15' (60 Hz)	1
	H95365	10-3 Cord - 15' (50 Hz)	1
31	H95187	Plug, 240V, 20A (60 Hz)	1
	H95189	Plug, 125V, 30A (60 Hz)	1
	H95223	Plug, 240V, 16A (50 Hz)	1
32	H95449-25750	Fitting, Cord Grip, M25, .512-.750	2
33	H95024-RESP	Enclosure, Rotary Contactor	1
34	H95449-25500	Fitting, Cord Grip, M25, .354-.500	2
35	H95025-S16	Rotary Starter, 10 - 16 Amp (220V)	1
	H95025-S25	Rotary Starter, 20 - 25 Amp (110V)	1
36	H97273	Machine Screw, 8-32 x 1/2	2
37	H95419	Foot Pedal Switch Executive 72	1
38	H95102	Foot Pedal Guard	1
39	H97285	Washer, Star, #6	2
40	H97283	Screw, Thread Cutter, 6-32 x 1/2	2
41	H50058	Rubber Foot	2
42	H97010	Benchtop Frame Model 1690	1
43	H97011N	Cart Frame Model 1691	1
44	H95190	Receptacle, 110V, 30A (60Hz) (Not Pictured)	1
	H95188	Receptacle, 240V, 20A (60Hz) (Not Pictured)	1
	H95224	Receptacle, 230V, 16A (50Hz) (Not Pictured)	1

12.0 Service

For repair authorization or parts please call: **Huth Ben Pearson International, LLC**
Customer Service
1-800-558-7808

For the purchasers convenience we are providing an assembly parts selection from which the purchaser can order, if you choose to attempt to make repairs. For professional quality repair Huth Ben Pearson recommends contacting your local distributor.

13.0 Warranty

This warranty is made for the exclusive benefit of the original owner and is not transferable. There is no other warranty applicable to Huth Ben Pearson Products, and no representative has any authority to make any representation, promise, or agreement except as stated in the warranty.

This warranty is for one year from the date of original invoice, Huth Ben Pearson will repair the expander and/or part components if found to be defective in material and workmanship without cost to the purchaser. Following the first 90 days from the date of the original invoice, replacement parts are shipped to the purchaser freight collect. Returns of defective parts must be pre-approved and are shipped prepaid to Huth Ben Pearson.

In effecting such repairs, Huth Ben Pearson may at its own discretion, repair or replace any part which it finds to be defective.

HUTH BEN PEARSON INTERNATIONAL, LLC

MANUFACTURER'S WARRANTY

Huth Ben Pearson International, LLC (the "Manufacturer") warrants Manufacturer's products (the "Products") will be free from defects in manufacture by Manufacturer (the "Warranty"). The Warranty will be effective and valid for a period of one (1) year, beginning on the date in which Manufacturer ships the Product (the "Warranty Period") from manufacturer's facility directly to Manufacturer's customer (the "Customer"). The Warranty shall obligate Manufacturer to repair or replace (in Manufacturer's discretion) defective Products as provided below. Manufacturer shall maintain records, including Manufacturing Process Instructions, for all Products for a period equal to the Warranty Period. Upon the expiration of the Warranty Period, Manufacturer will have no further obligation to Customer with respect to a Product that is non-conforming and/or defective for any other reason.

To take advantage of the Warranty, Customer must take the following three steps: (1) Customer must promptly notify Manufacturer after Customer becomes aware that it has a defective Product, which in all events must be within thirty (30) days of Customer's discovery of the defect and within the Warranty Period; and (2) Customer must provide detailed digital pictures and/or must return the defective Product to Manufacturer immediately thereafter and/or make the Product available to Manufacturer for inspection (at Manufacturer's request/discretion), and in no event more than thirty (30) days after any notification provided in (1) above; and (3) Customer must insure the defective Product until Manufacturer receives and accepts it. After Customer has taken the above steps, Manufacturer will evaluate the Product to determine if Customer's warranty claim is valid and to determine what, if any, remedy is available to Customer. Customer must return or make available all defective Products with complete documentation associated with the defective Product.

The Warranty shall be invalidated if: (1) damage to the Product is the result of misuse or abuse by Customer or any end user of the Product; or (2) if the Product has been modified by Customer or any end user of the Product; or (3) if any defects in the Products are caused as a result of Manufacturer following Customer's specifications in manufacture that contain any problems, faults, errors, miscalculations, or discrepancies in the specifications. If Manufacturer decides to repair or replace the defective Product, Manufacturer will ship the repaired or replaced Product (both, a "Repaired Product") F.O.B. the shipping point and all of the provisions in this Warranty pertaining to the Products will apply to the Repaired Product, including but not limited to, the risk of loss provisions set forth above. Notwithstanding the prior sentence, the Warranty Period for a Repaired Product will not be restarted, but instead will expire at the same time as though the Repaired Product was never a defective Product but rather the Product at all times.

THE WARRANTY PROVIDED HEREUNDER IS THE ONLY WARRANTY MANUFACTURER PROVIDES TO CUSTOMER, AND SHALL BE IN THE PLACE OF ANY OTHER EXPRESS OR IMPLIED WARRANTIES, INCLUDING ANY IMPLIED WARRANTIES OF MERCHANTABILITY, FITNESS FOR A PARTICULAR PURPOSE, TITLE OR NONINFRINGEMENT, OR ANY OTHER OBLIGATION ON MANUFACTURER'S PART. NO ORAL OR WRITTEN STATEMENTS MADE BY MANUFACTURER, EXCEPT THOSE MADE IN THIS WARRANTY SHALL BE CONSIDERED A WARRANTY OR CONSIDERED TO HAVE ANY LEGAL EFFECT. ADDITIONALLY, NO SAMPLES, MODELS, OR PROTOTYPES MANUFACTURER PROVIDES TO CUSTOMER SHALL BE CONSIDERED A WARRANTY OR CONSIDERED TO HAVE ANY LEGAL EFFECT.

CUSTOMER'S EXCLUSIVE REMEDIES FOR MANUFACTURER'S BREACH OF WARRANTY SHALL BE ONE OF THE FOLLOWING: (A) THE REPAIR OR REPLACEMENT OF THE DEFECTIVE PRODUCT; OR (B) THE REFUND OF THE PRICE CUSTOMER PAID FOR THE DEFECTIVE PRODUCT. THE REMEDIES SET FORTH ABOVE SHALL BE DETERMINED IN MANUFACTURER'S SOLE DISCRETION. ANY SHIPPING COSTS ASSOCIATED WITH VALID WARRANTY PRODUCTS THAT MANUFACTURER AND CUSTOMER HAVE MUTUALLY AGREED UPON SHALL BE PAID BY MANUFACTURER.

UNDER NO CIRCUMSTANCES WILL MANUFACTURER BE LIABLE FOR ANY INDIRECT, SPECIAL, PUNITIVE, INCIDENTAL, OR CONSEQUENTIAL DAMAGES RESULTING FROM THE SALE, MANUFACTURE, OR USE OF THE PRODUCT, WHETHER BASED UPON BREACH OF WARRANTY, BREACH OF CONTRACT, NEGLIGENCE, STRICT LIABILITY, OTHER TORT, OR ANY OTHER LEGAL THEORY. MANUFACTURER'S LIABILITY IN CONNECTION WITH THE SALE OR USE OF THE PRODUCT WILL NOT EXCEED THE PRICE OF THE PRODUCT UNDER ANY CIRCUMSTANCES. BY WAY OF EXAMPLE, IF A SINGLE PRODUCT CAUSES ANY DAMAGES, MANUFACTURER'S LIABILITY WILL NOT EXCEED THE PRICE OF THAT SINGLE PRODUCT. DAMAGES REFERRED TO IN THIS PROVISION INCLUDE, BUT ARE NOT LIMITED TO, LOSS OF PROFITS, REVENUE, OR USE OF THE PRODUCT; THE COST OF CAPITAL, SUBSTITUTE PRODUCTS, REPLACEMENT PRODUCTS, OR DOWN TIME; ANY CLAIMS OF THIRD PARTIES, INCLUDING, BUT NOT LIMITED TO, CUSTOMER'S CUSTOMERS OR OTHER USERS; DEATH; PERSONAL INJURY; AND INJURY TO PROPERTY.