

Experience The Power Of Pearson



MC-59

BP-79

MC-59HS

MB-97



**Quality Built
Pipe Bending Machines For
The Exhaust System Specialist**

Ben Pearson Delivers The Complete Bender Package.

At Ben Pearson we have one basic philosophy—to design and build the finest muffler shop pipe bending equipment available on the market. It's with this attitude, this basic philosophy, that we approach every pipe bender we build.

It's a total commitment to follow-through. From initial product design, through rigorous quality control standards, to finished product. It's what keeps us ahead of the competition, and it's what continues to make us the clear leader in the exhaust industry.

We've Set The Standard For The Industry To Follow.

When we designed and built our first machine we built in many special operator convenience features, special features which were at the time industry "firsts." It's these special features that separate us from competitive models. But features alone don't make the product. It takes much more. At Ben Pearson we go well beyond product manufacturing, we also offer the industry's best service support, training and product guarantee. It's your assurance that when you invest in a Pearson pipe bender you're getting a rock solid, American made product that will give you a full day's work for many years to come.



TD-3 Package

TS-3 Package



Ben Pearson Offers Features That Continue To Lead By Design.

Other manufacturers can design and build a pipe bender, but it takes a company with a strong understanding of the marketplace to deliver a machine that offers, not just the features you need, but also the features you want. Our line of pipe bending machines deliver.

Take a close look at the features we build into each Ben Pearson bender. But also look closely at the detail we build

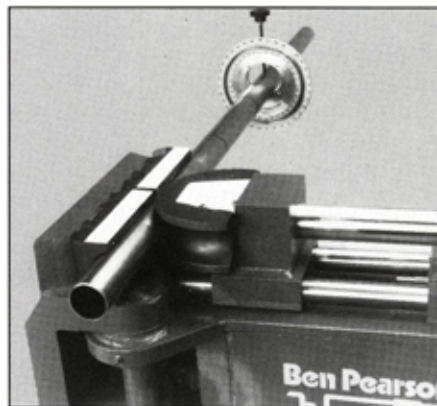

into each machine. You won't find quality being sacrificed at any level of production.

180° Bend On A 5" Radius

Try this with another pipe bender and the results may not be what you expect. With a Ben Pearson bender you'll get a perfect 180° bend on a 5" radius (our 3" and 4" ram dies also make perfect bends possible, even at maximum bend). What you won't get is a pipe that is crimped or collapsed. The reason for this is simple—Ben Pearson's unique die construction eliminates the problem of the pipe locking on the die. It may seem like a small feature, but if you're the operator of a pipe bender, it's an extra feature you'll appreciate.

Quick-Change Bending Dies

Operator convenience is the name of the game in the exhaust industry. The quicker the job, the more profit you can make. At Ben Pearson we know this, and that's why we designed our quick-change dies for maximum speed and versatility. You won't find any bolts, pins or cumbersome pusher blocks. It's quick and easy with Ben Pearson.

3" Bending And Expanding Capability

With today's changing marketplace every exhaust professional has to have 3" capability. That's why Ben Pearson offers a full range of 3" bending dies and expanders. We even offer 3 1/2" and 4" expanders. Hey, if you've got a tough job to do, we'll help you get it done by delivering the tools and equipment you need to get the job done right. It's called being a leader and we do it better than anyone.

Longer Stroke Main Cylinder

We've added an extra 3" stroke to the main cylinder of our bender. This unique operator convenience feature gives you an extra 6" of space between the edge of the ram-die and the edges of the back shoes. You have more room to feed the pipe through the machine. There's no need for pusher blocks which can become cumbersome and time consuming when changing your die. Ben Pearson developed the longer stroke main cylinder for added operator convenience.

Automatic Motor Cut-Off

Saves operator time, reduces wear on the electrical and hydraulic system and minimizes electrical costs.



Plastic and Nonplastic Bend Data Cards

DataMaster Bend Data System



- POWER
- SPEED
- FEATURES
- CONVENIENCE

Computerized Bend Data And Standard Bend Data Cards.

Ben Pearson offers two types of bend data sources, DataMaster Computerized bend data system and our standard plastic coated or nonplastic bend data cards. Both give you reliable bending information to ensure a fast and accurate bend. Ben Pearson is the only company to offer four different bend data systems from four OEM pipe manufacturers.

So it's up to you...DataMaster Computerized data system or our standard Card Data system. Whichever you choose, because it's from Ben Pearson you know it's the best.

End-Of-Pipe Operation

Most major manufacturers offer some type of end-finishing equipment on their benders. At Ben Pearson we offer not one—but two end-of-pipe finishing systems as standard equipment on the Pearson MC-59, Pearson Hi-Speed and BendMaster. By offering two end-finishing systems on our bender we can make your job easier, safer and much more convenient.

Segment Expander

Pearson's segment expander offers some unique features that make it easier to operate than competitive models. Like the ability to expand, flare or ball joint when a bend is very close to the end of the pipe. The unique bull's eye sight gauge, with an accurate and complete O.D. and I.D. setting chart, ensures accurate connections and slip fits. Plus, you can easily make 1 1/2" through 3" expansions without an arbor change.

Clamp-Down Swager

Swage, flares, ball joints, reducing, flange (from 1 1/4"-3")—you name the operation that needs to be performed and you can bet that a Ben Pearson bender can handle it. The construction of the Ben Pearson clamp-down swager was designed for only one person—you, the operator. The popular GM/Toyota/Ford super flanging tools, which were developed first by Ben Pearson, provide you with perfect flanges with only a one-step operation.

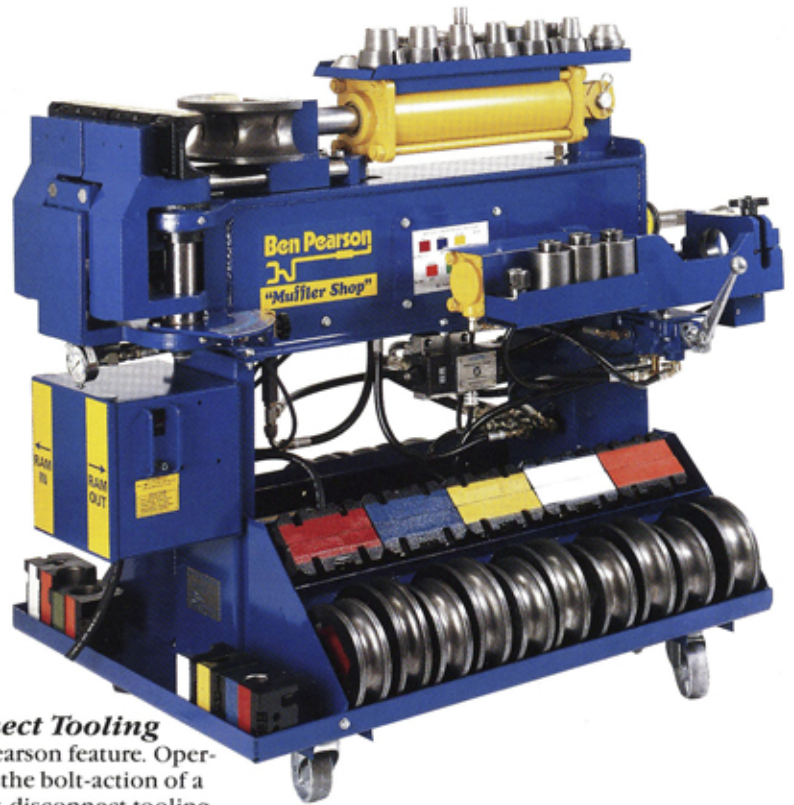

Quick-Disconnect Tooling

A special Ben Pearson feature. Operating very similar to the bolt-action of a rifle, Pearson's quick-disconnect tooling eliminates threading, which can strip over time, and cumbersome spring pins which can jam and shear. Quick-disconnect tooling—another example of the unique features offered by Ben Pearson.

We Back Our Products With Service After The Sale And A Rock Solid Warranty.

At Ben Pearson we don't sell you a piece of equipment and then forget you. When you buy a Pearson bender you're getting a team of support personnel that are totally responsive to your needs and problems. It's called a total commitment to follow-through, and nobody does it better than Ben Pearson. We demand it from our people—our customers expect it from us.



Ben Pearson Provides A Lifetime Limited Warranty

We don't have to offer as complete a warranty as we do, many of our competitors don't. Our limited lifetime warranty shows the commitment we have to our products' reliability and the commitment we have to our customers.

We Offer In-Depth Training

For operators who are new to the exhaust service business, Ben Pearson offers extensive training courses on the utilization of our line of muffler shop pipe benders. The course includes training in all phases of bending and machine maintenance. Ben Pearson also offers a complete video training tape that walks the user through every step of the bending process.

Ben Pearson Delivers The Total Package.

That's what you get when you invest in a Ben Pearson bender...the total package you need to get the job done right. American-made technology. The best warranty in the business. Unique operator convenience features that make your job easier and faster. You get all of this plus a support network that is totally responsive to your needs. These are the reasons you should consider Ben Pearson. These are the reasons why Ben Pearson continues to Lead By Design.

MC-59

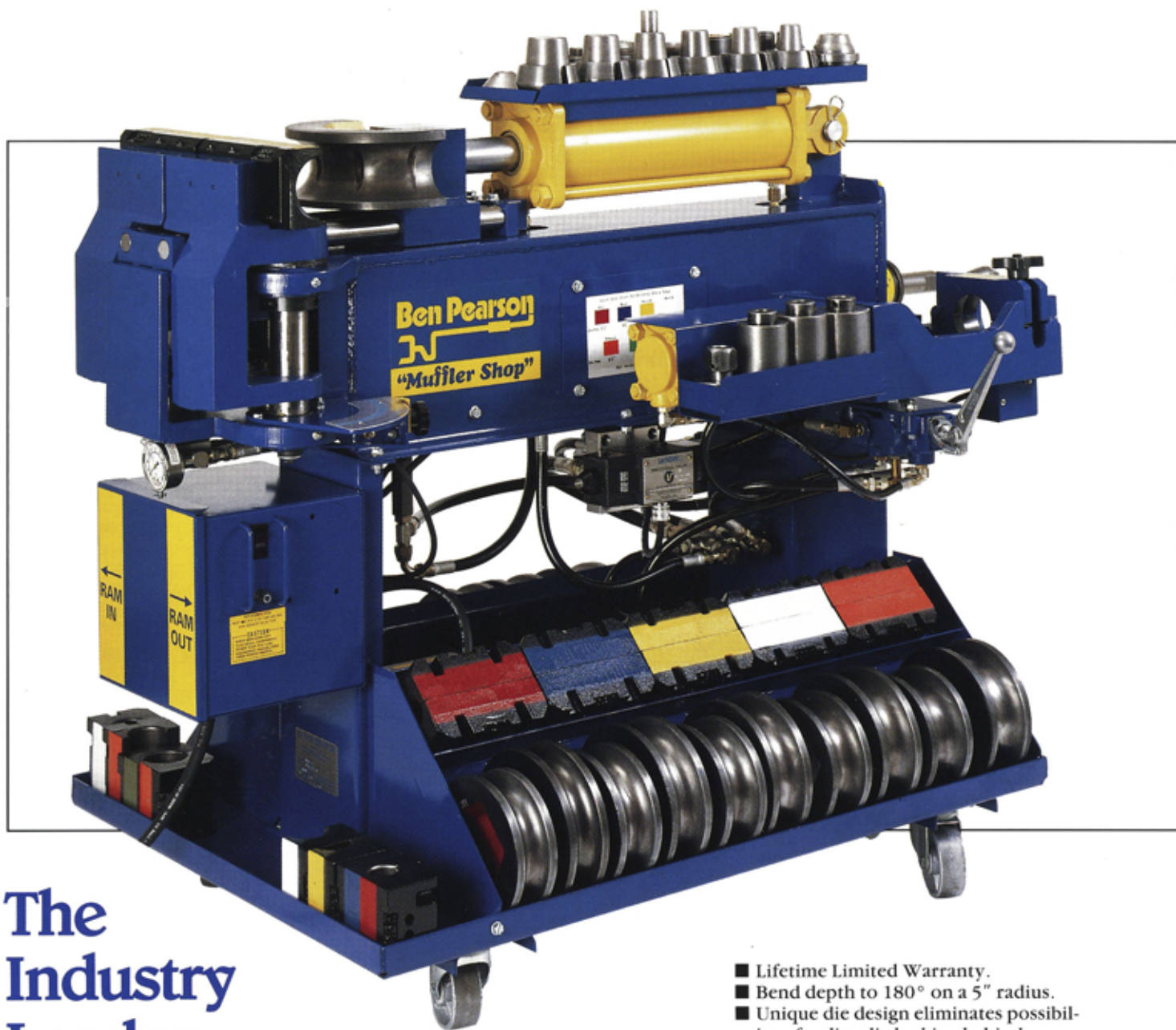

The Industry Leader In Exhaust Service.

The MC-59 from Ben Pearson is truly the ultimate in bender technology. Incorporating state-of-the-art technology, the MC-59 leads the industry in operator convenience features—180° bend on a 5" radius, 3" bending capability and a rugged electrical and hydraulic system that will perform over the long haul. Plus, the MC-59 offers two end-of-pipe systems for quick and easy operation.

The MC-59 from Ben Pearson is truly the "leader" in the exhaust service repair industry.

- Lifetime Limited Warranty.
- Bend depth to 180° on a 5" radius.
- Unique die design eliminates possibility of radius die locking behind back shoes.
- Bending capability through 3".
- Quick-change dies.
- Color-coded dies.
- Spring-loaded die carriage.
- Knee control of ram die.
- Energy efficient dual stage hydraulic pump.
- Automatic depth-of-bend.
- Automatic retraction of ram die.
- Automatic motor cut-off.
- 220 volt single phase, 60 cycle. (Three phase, 50 cycle and other voltages available.)
- Heavy-duty 4 HP motor.

MC-59

Leading By Design



180° Bend On A 5" Radius.

Try this with another pipe bender and the results may be less than spectacular. With the Ben Pearson pipe bender you'll get a perfect 180° bend on a 5" radius die (our 3" and 4" ram dies also make perfect bends possible even at maximum bend). What you won't get is a pipe that is crimped or collapsed. The reason for this is very simple—Ben Pearson's unique die construction eliminates the problem of the pipe locking on the die. This extra feature saves you, the operator, time and money.

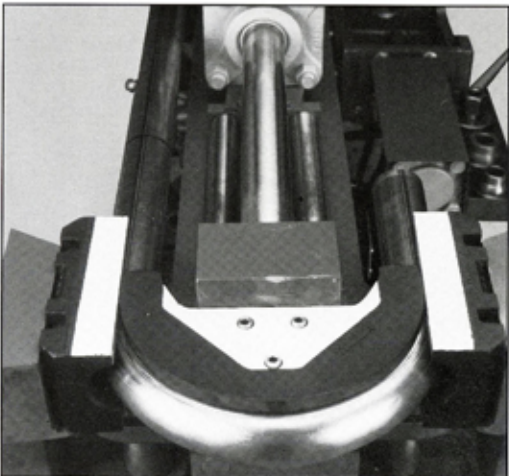

Longer Stroke Main Cylinder.

We've added an extra 3" stroke to the main cylinder. The benefits are obvious—you get an extra 6" of space between the edge of the ram die and the edges of the back shoes. You have more room to feed pipe through the machine, thus eliminating the need for cumbersome and time consuming pusher blocks. Ben Pearson developed the longer stroke main cylinder for operator convenience.

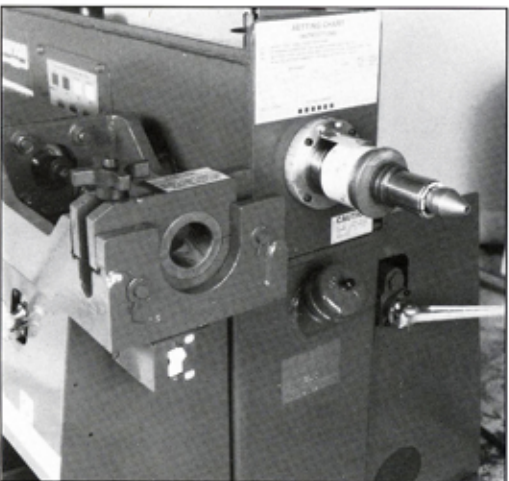

The MC-59 Offers Two End-of-Pipe Systems.

To make your job easier, faster and more efficient, the MC-59 offers two end-of-pipe systems as standard equipment. The segment expander offers some unique features that make it easier to operate than competitive models. Like the ability to expand, flare or ball joint close to the end of the pipe. Plus, the unique bull's eye gauge, with an accurate and complete O.D. and I.D. setting chart, ensures accurate connections and slip fits.

The clamp-down swager system on the MC-59 gives you the flexibility to swage, flare, ball joint, reduce and flange. In fact, you name the job that needs to be done and this machine can do it. Plus, for more power and increased operator safety, the clamp-down swager system operates on a separate cylinder.

BP-79



Power And Affordability Rolled Into A Hard Working Bender.

If you're looking for a powerful bender that's got the features you need to get the job done, take a long look at the BP-79 from Ben Pearson. It'll give you all the power you need at an affordable price.

- Main cylinder mount is solid welded internally, plus welded end plate for added support.
- Lifetime Limited Warranty.
- Bend depth to 180° on a 5" radius.
- Quick disconnect tooling.
- Unique die design eliminates possibility of radius die locking behind back shoes.
- Hands-free bending utilizing padded knee lever control for fast accurate bends.
- 3" bending capacity.
- Quick-change dies.
- Color-coded dies.
- 220 volt single phase, 60 cycle. (optional 3 phase), 60 cycle.
- Rugged, energy efficient, Baldor 4 HP motor.

MC-59HS



The Ultimate In Bending Technology.

We've taken bender technology one step further with the MC-59 HI-SPEED. No matter what your exhaust repair volume, the Pearson HI-SPEED bender was designed and built for you. With over twice the bending speed of conventional benders, the Pearson HI-SPEED utilizes a rugged 7½HP motor combined with a heavy-duty electrical and hydraulic system. This bender was designed for heavy work...and it performs.

The MC-59 HI-SPEED, it delivers more B.P.H. (bends per hour) than anything on the market today.

- Limited Lifetime Warranty.
- Bend depth to 180° on a 5" radius.
- Unique die design eliminates possibility of radius die locking behind back shoes.
- Bending capability through 3".

- Hydraulic oil cooler.
- Quick-change dies.
- Color-coded dies.
- Spring-loaded die carriage.
- Knee control of ram die.
- Energy efficient dual stage hydraulic pump.
- Automatic depth-of-bend.
- 220 volt, single phase, 60 cycle. (Three phase, 50 cycle available.)
- Automatic retraction of ram die.
- Automatic motor cut-off.
- Auxiliary on-off switch for end-of-pipe operations.
- Heavy-duty 7½HP motor.
- Extra capacity hydraulic reservoir.
- Two end-of-pipe systems.

MB-97



Shown with optional die trays.

It's Loaded With All The Automatic Operator Convenience Features You Need, Without The Price Tag To Match.

If you were under the impression that you had to invest a lot of cash to get a solid bender, loaded with the features you need, we're about to prove you wrong. Just check out the automatic features on Ben Pearson's MB-97 - automatic depth-of-bend, automatic ram retraction, automatic motor cut-off, and that's just the beginning list of features.

The new MB-97 from Ben Pearson delivers it all - power, features, and durability, but it's available at a very affordable price.

If you're looking for the perfect bender, the bender that will get the job done, the MB-97 is the bender you've been looking for.

- Lifetime Limited Warranty.
- Bend depth to 180° on a 5" radius.
- Unique die design eliminates possibility of radius die locking behind back shoes.
- Utilizes a double-ended, dual action cylinder, for both solid and segmented end finishing.
- Bending capability through 3".
- Quick-change dies.
- Color-coded dies.
- Spring-loaded die carriage.
- Knee control of ram die.
- Energy efficient dual stage hydraulic pump.
- Automatic depth-of-bend.
- Automatic retraction of ram die.
- Automatic motor cut-off.
- 220 volt single phase, 60 cycle. (Three phase, 50 cycle and other voltages available.)
- Heavy-duty 4 HP motor.
- Optional die trays available.

DIE PACKAGES



Super 80

BENDING DIES

RADIUS DIES
 112-3 200-5
 134-4 214-4
 200-3 214-5
 200-4 212-5

BACK SHOES (2)
 112-1 214-1
 134-1 212-1
 200-1

HALF SHOES (1)
 112-H 214-H
 134-H 212-H
 200-H

END FINISHING TOOLS—SEGMENT

EXPANDERS
 1½"-1⅝"
 1¾"-2"
 2⅛"-2½"

END FINISHING TOOLS—SOLID

COLLETS (2 Required)
 1½" 2¼"
 1¾" 2½"
 2"

SWAGERS
 1½" 2¼"
 1¾" 2½"
 2"

SOLID DIE FLARE
 45° & 90°



Super 120

BENDING DIES

RADIUS DIES
 112-3 200-5
 134-3 214-4
 134-4 214-5
 178-4 212-4
 200-3 212-5
 200-4

BACK SHOES (2)
 112-1 200-1
 134-1 214-1
 178-1 212-1

HALF SHOES (1)
 112-H 200-H
 134-H 214-H
 178-H 212-H

THREE QUARTER SHOES (1)
 200-0 214-0

END FINISHING TOOLS—SEGMENT

EXPANDERS
 1½"-1⅝" 2⅛"-2½"
 1¾"-2"
 BUICK BALL TOOLS
 2" 2½"
 2¼"

END FINISHING TOOLS—SOLID

COLLETS (2 Required)
 1½" 2"
 1¾" 2¼"
 1⅞" 2½"
 SWAGERS
 1½" 2"
 1¾" 2¼"
 1⅞" 2½"

FEMALE BALL JOINT
 1¾" & 2" 2¼" & 2½"

SUPER FLANGE
 1½" & 2"

SOLID DIE FLARE
 45° & 90°

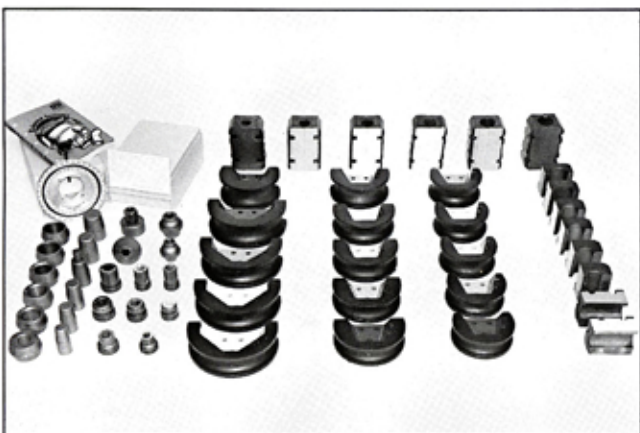

Super 150

BENDING DIES

RADIUS DIES
 112-3 200-4
 112-4 200-5
 134-3 214-3
 134-4 214-4
 178-3 214-5
 178-4 212-4
 178-5 212-5
 200-3

BACK SHOES (2)
 112-1 200-1
 134-1 214-1
 178-1 212-1

HALF SHOES (1)
 112-H 200-H
 134-H 214-H
 178-H 212-H

THREE QUARTER SHOES (1)
 200-0 214-0

END FINISHING TOOLS—SEGMENT

EXPANDERS
 1½"-1⅝" 2⅛"-2½"
 1¾"-2"
 BUICK BALL TOOLS
 2" 2½"
 2¼"

FLARES 45°
 1¾" & 2¼" 2" & 2½"
 1⅞" & 2⅝"

ACCESSORIES
 Deluxe Program Cards
 Rotational Dial

END FINISHING TOOLS—SOLID

COLLETS (2 Required)
 1½" 2"
 1¾" 2¼"
 1⅞" 2½"

SWAGERS
 1½" 2"
 1¾" 2¼"
 1⅞" 2½"

FEMALE BALL JOINT
 1¾" & 2" 2¼" & 2½"

SUPER FLANGE
 1½" & 2"

SOLID DIE FLARE
 45° & 90°

END FINISHING TOOLS/Solid



SWAGERS

| Size | Part # | Size | Part # |
|--------|--------|--------|--------|
| 1 1/4" | 61245 | 2" | 61233 |
| 1 3/8" | 61243 | 2 1/8" | 61506 |
| 1 1/2" | 61241 | 2 1/4" | 61231 |
| 1 5/8" | 61239 | 2 3/8" | 61750 |
| 1 3/4" | 61237 | 2 1/2" | 61229 |
| 1 7/8" | 61235 | 3" | 62231 |



COLLETS (2 required)

| Size | Part # | Size | Part # |
|--------|--------|--------|--------|
| 1 1/4" | 61432 | 2" | 61426 |
| 1 3/8" | 61431 | 2 1/8" | 61425 |
| 1 1/2" | 61430 | 2 1/4" | 61424 |
| 1 5/8" | 61429 | 2 3/8" | 61752 |
| 1 3/4" | 61428 | 2 1/2" | 61423 |
| 1 7/8" | 61427 | 3" | 62227 |

FEMALE BALL JOINTS



| Size | Part # |
|---------------|--------|
| 1 3/4"-2" | 60780 |
| 2 1/4"-2 1/2" | 60779 |

SOLID DIE FLARE



| Size | Part # |
|-----------|--------|
| 45° & 90° | 61049 |

SUPER FLANGE



| Size | Part # |
|---------------|--------|
| 1 1/2"-2" | 61258 |
| 2 3/4"-2 1/4" | 61792 |

REDUCERS



| Size | Part # |
|---------------|--------|
| 2 1/2"-2 1/4" | 61250 |
| 2 1/2"-2" | 61252 |
| 2 1/4"-1 1/2" | 61254 |
| 2"-1 1/4" | 62212 |
| 1 1/2"-1 1/8" | 62160 |
| 2 1/4"-2 1/2" | 62233 |
| 3"-2 1/4" | 62232 |



FLATTENING TOOL

| | |
|--------|-------|
| Part # | 61533 |
|--------|-------|

HEADER COLLECTOR TOOL

| | |
|--------|-------|
| Part # | 62216 |
|--------|-------|

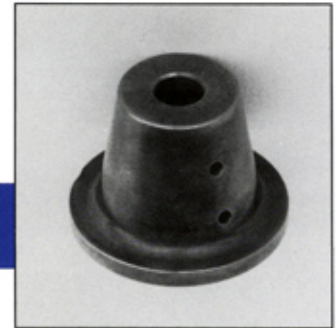

END FINISHING TOOLS/Segmented

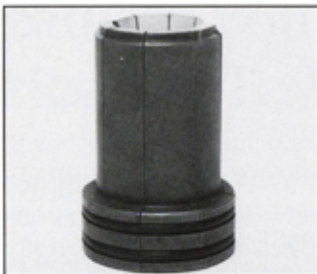

EXPANDERS

| Size | Part # |
|----------------------|--------|
| 1 1/4"-1 1/8" | 61046 |
| 1 1/2"-1 1/8" | 61967 |
| 1 3/4"-1 1/8"-2" | 61548 |
| 2 1/4"-2 1/4"-2 1/2" | 61549 |
| 2 1/2"-3" | 61550 |
| 3 1/2" | 62452 |
| 4" | 62453 |



COMBINATION BALL TOOLS MALE/FEMALE

| Size | Part # |
|--------|--------|
| 2" | 61544 |
| 2 1/4" | 61545 |
| 2 1/2" | 61546 |



FLARE 45°

| Size | Part # |
|-----------------------------|--------|
| 1 1/2" | 61136 |
| 1 3/4"-1 7/8"-2 1/4"-2 3/8" | 61542 |
| 2"-2 1/2" | 61778 |
| 3" | 60447 |



CHEVROLET FLANGE SEGMENT TOOL

| Size | Part # |
|--------|--------|
| 2" | 60857 |
| 2 1/4" | 60867 |



SMALL ARBOR

| Size | Part # |
|---------------|--------|
| 1 1/4"-1 3/8" | 61261 |

BENDING DIES & ACCESSORIES

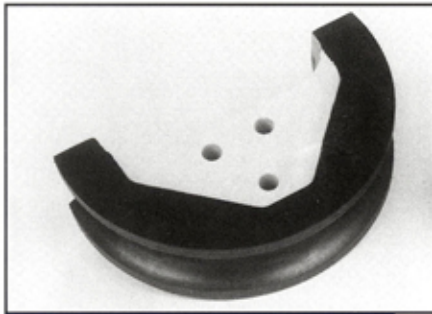

RADIUS DIES

3" RADIUS

| Size | Part # |
|--------|--------|
| 1" | 62259 |
| 1 1/4" | 60876 |
| 1 3/8" | 60877 |
| 1 1/2" | 60221 |
| 1 5/8" | 61044 |
| 1 3/4" | 60225 |
| 1 7/8" | 60230 |
| 2" | 60235 |
| 2 1/8" | 61084 |
| 2 1/4" | 60240 |

4" RADIUS

| Size | Part # |
|--------|--------|
| 1 3/8" | 61260 |
| 1 1/2" | 60222 |
| 1 5/8" | 60878 |
| 1 3/4" | 60226 |
| 1 7/8" | 60231 |
| 2" | 60236 |
| 2 1/8" | 61085 |
| 2 1/4" | 60241 |
| 2 3/8" | 61114 |
| 2 1/2" | 60245 |

5" RADIUS

| Size | Part # |
|--------|--------|
| 1 5/8" | 61083 |
| 1 3/4" | 60227 |
| 1 7/8" | 60232 |
| 2" | 60237 |
| 2 1/8" | 61062 |
| 2 1/4" | 60242 |
| 2 3/8" | 61115 |
| 2 1/2" | 60246 |
| 2 3/4" | 61121 |
| 3" | 61020 |

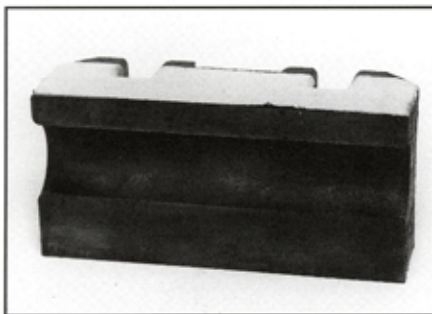

BACK SHOES (2 required)

| Size | Part # |
|--------|--------|
| 1" | 62260 |
| 1 1/4" | 61107 |
| 1 3/8" | 61109 |
| 1 1/2" | 61000 |
| 1 5/8" | 61111 |
| 1 3/4" | 61001 |
| 1 7/8" | 61002 |
| 2" | 61003 |
| 2 1/8" | 61086 |
| 2 1/4" | 61004 |
| 2 3/8" | 61116 |
| 2 1/2" | 61005 |
| 2 3/4" | 61122 |
| 3" | 61006 |

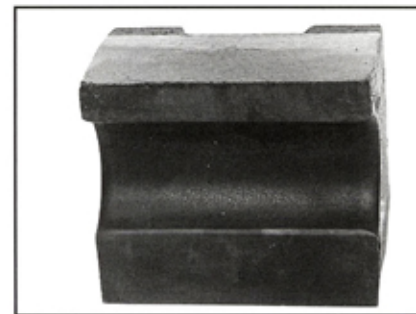

HALF SHOES

| Size | Part # |
|--------|--------|
| 1" | 62602 |
| 1 1/4" | 61108 |
| 1 3/8" | 61110 |
| 1 1/2" | 61014 |
| 1 5/8" | 61112 |
| 1 3/4" | 61015 |
| 1 7/8" | 61016 |
| 2" | 61017 |
| 2 1/8" | 61087 |
| 2 1/4" | 61018 |
| 2 3/8" | 61117 |
| 2 1/2" | 61019 |
| 2 3/4" | 61123 |
| 3" | 62658 |

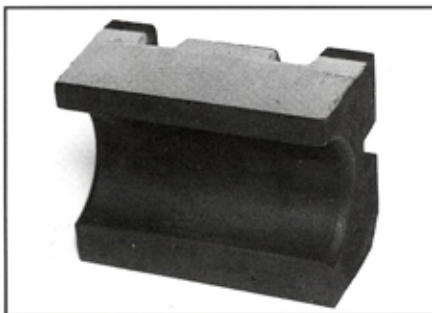

THREE QUARTER SHOES

| Size | Part # |
|--------|--------|
| 1 1/4" | 61879 |
| 1 3/8" | 61880 |
| 1 1/2" | 61008 |
| 1 5/8" | 61045 |
| 1 3/4" | 61009 |
| 1 7/8" | 61010 |
| 2" | 61011 |
| 2 1/8" | 61783 |
| 2 1/4" | 61012 |
| 2 3/8" | 61784 |
| 2 1/2" | 61013 |
| 2 3/4" | 62011 |
| 3" | 62449 |

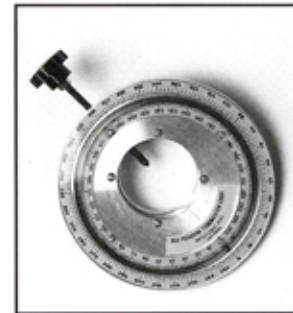

ROTATIONAL DIAL

Part #60100

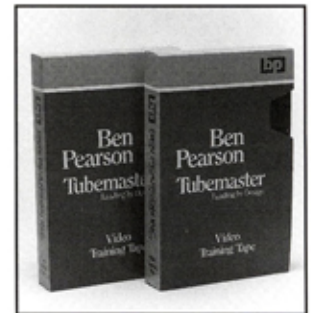

VIDEO TRAINING TAPE

Part #62182

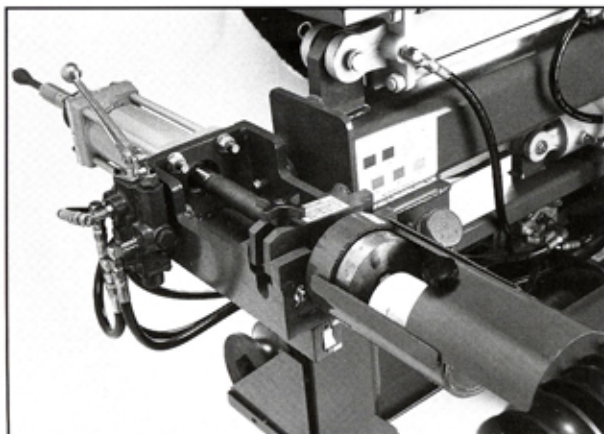

CrushMaster 3

Part #62750

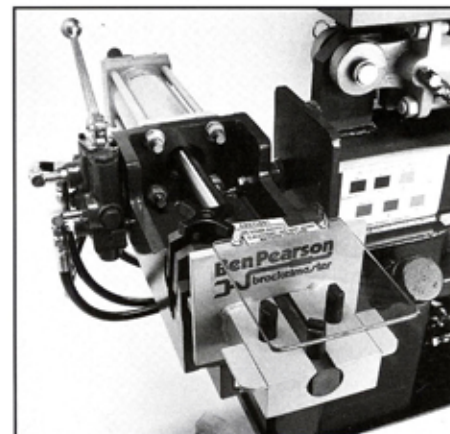

BracketMaster

Part #62699

Lifetime Limited Warranty Pipe Bending Machines

Ben Pearson Tubemaster Pipe Bending Machines are the finest in the world. They are produced from the highest quality materials and components, machined to precise tolerances, assembled with attention to the smallest detail and backed by the industry's best service team. It is with this confidence that Ben Pearson Tubemaster offers the best warranty in the industry—a lifetime limited warranty. The features of the warranty are as follows:

- Ben Pearson Tubemaster warrants the main frame and structural components of each Ben Pearson bending machine to be free from defects in material and workmanship, under normal use as delivered to the original purchaser, for the **LIFETIME** of the product.
- Ben Pearson warrants the electrical motor and hydraulic components and all bending dies (radius dies, back shoes, three quarter shoes and half shoes) under normal use as delivered to the original purchaser, for **TWO** years from the date of invoice.
- Ben Pearson warrants end finishing tooling and accessories, solid and segmented, and electrical switches under normal use as delivered to the original purchaser for **ONE** year date of invoice.

This warranty does not apply to normal wear or to misuse.

Defective parts covered by this warranty will be repaired or replaced, at the option of Ben Pearson Tubemaster, at its home office, transportation prepaid, within the applicable warranty period. Following the first 90 days from date of original invoice, replacements parts will be shipped to the purchaser freight collect.

Other than the warranty with reference to the repair or replacement of defective parts as more specifically as set out hereinabove, **BEN PEARSON TUBEMASTER MAKES NO WARRANTIES, EXPRESS OR IMPLIED, OF MERCHANT ABILITY OR OTHERWISE WHICH EXTEND BEYOND THE DESCRIPTION OF THE PRODUCT.** In no event will the sales representative, wholesale dealer, Ben Pearson Tubemaster, or any company affiliated with it or them be liable for incidental or consequential damages or injuries, including but not limited to loss of profit, rental of substitute equipment or other commercial loss, purchaser's sole and exclusive remedy being as provided hereinabove.

This warranty may not be enlarged or modified in any manner whatever except in writing signed by an executive officer of Ben Pearson Tubemaster. It is the policy of Ben Pearson Tubemaster to improve its product whenever it is possible and practical to do so. Ben Pearson Tubemaster reserves the right to make changes or add improvements at any time without incurring any obligation to make such changes or add such improvements to products previously sold.



A Division of Quest Corporation

P.O. Box 5668 Pine Bluff, AR 71611 • 1-800-436-1327 • 870-534-6411 • Fax 870-534-3177

www.ben-pearson.com • e-mail: sales@ben-pearson.com